

# CEILING MOUNTED WORKSTATION BRIDGE CRANES



*Cost-effective Solutions  
For Lifting and Moving Material*

# CETILING MOUNTED WORKSTATION BRIDGE CRANES

*SPANCO Lifting Solutions...*

*Increase worker productivity,  
ease work flow and provide cost  
effective materials handling—  
this is what SPANCO lifting  
solutions can do for you.*

*No matter the material handling  
problem, SPANCO has a solution.*



## TABLE OF CONTENTS

|  | page    |
|--|---------|
| Solving Your Material Handling Problems...                           | 3       |
| Quality Considerations   | 3       |
| Determining Capacity, Width, Length, and Height                      | 4       |
| Easy Installation and Modular Design                                 | 5       |
| Design Factors   | 6       |
| System Options   | 7       |
| Components   | 9       |
| Runway Support Systems   | 11      |
| Overview for Specification Charts                                    | 13      |
| Chart Diagrams   | 14      |
| System Specifications  | 15      |
| Dimensional Charts   | 16 - 24 |
| Trussed Track 20' Support Centers/<br>Plain Track 6' Support Centers | 16-20   |
| Plain Track 9' Support Centers                                       | 19      |
| Trussed Track 25' Support Centers                                    | 21-23   |
| Trussed Track 30' Support Centers                                    | 23-24   |



*In addition to providing solutions, we provide quality. Quality construction to ensure long life and easy, ergonomic service. Whether you need crane coverage for an area with minimal building support or coverage for a small workstation, SPANCO can provide an answer with our full lines of gantry cranes, jib cranes, and SPANCO enclosed track workstation bridge cranes.*

# STAND ALONE WORKSTATION BRIDGE CRANES

## SOLVING YOUR MATERIAL HANDLING PROBLEMS WITH STAND ALONE WORKSTATION BRIDGE CRANES

SPANCO stand alone workstation bridge cranes provide ideal, cost effective material handling solutions...

**If you rent your building:** Stand alone systems do not become a permanent part of a structure once installed, allowing for relocation.

**Your structural building support is inadequate for an overhead ceiling mounted crane:** The only mounting requirement is a standard concrete building floor (in most cases).

**A specific area needs coverage, however you don't want to tie up your existing overhead crane:** Stand alone SPANCO workstation bridge crane systems can provide coverage for individual work areas.

- **Easy movement:** An operator could be pushing a 1000 lb. load, however the operator will experience the force of approximately 10 lb. to begin moving the load and 8 lb. to continue moving the load (100 to 1 ratio). Also a manual crane operates more quickly than a motorized crane.
- If the application requires moving heavier loads up to two tons or bridge travel over an inaccessible area, then a motorized system can be used efficiently. (See page 7)

## QUALITY CONSIDERATIONS

- **Low profile steel track** allows for full utilization of ceiling space. SPANCO systems are three times easier to operate and control than patented track systems.
- **"V" shaped profile** prevents dirt accumulation inside tracks and maintains alignment of end trucks and trolley wheels, ensuring smooth movement.

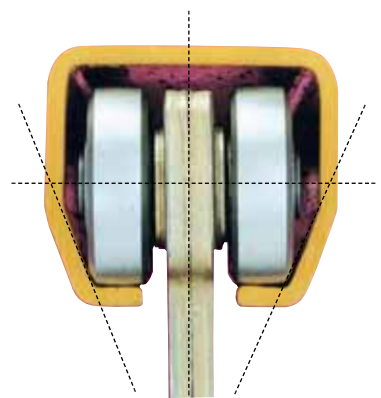

- **Trussed steel track design** increases span with fewer runway supports, lessening work area interference.



*Standard large diameter polyamide wheels provide smooth ergonomic*

*movement and long operating*

*life. Optional steel wheels are available at no extra cost.*



*Bronze wheels for hazardous*

*locations are also available.*



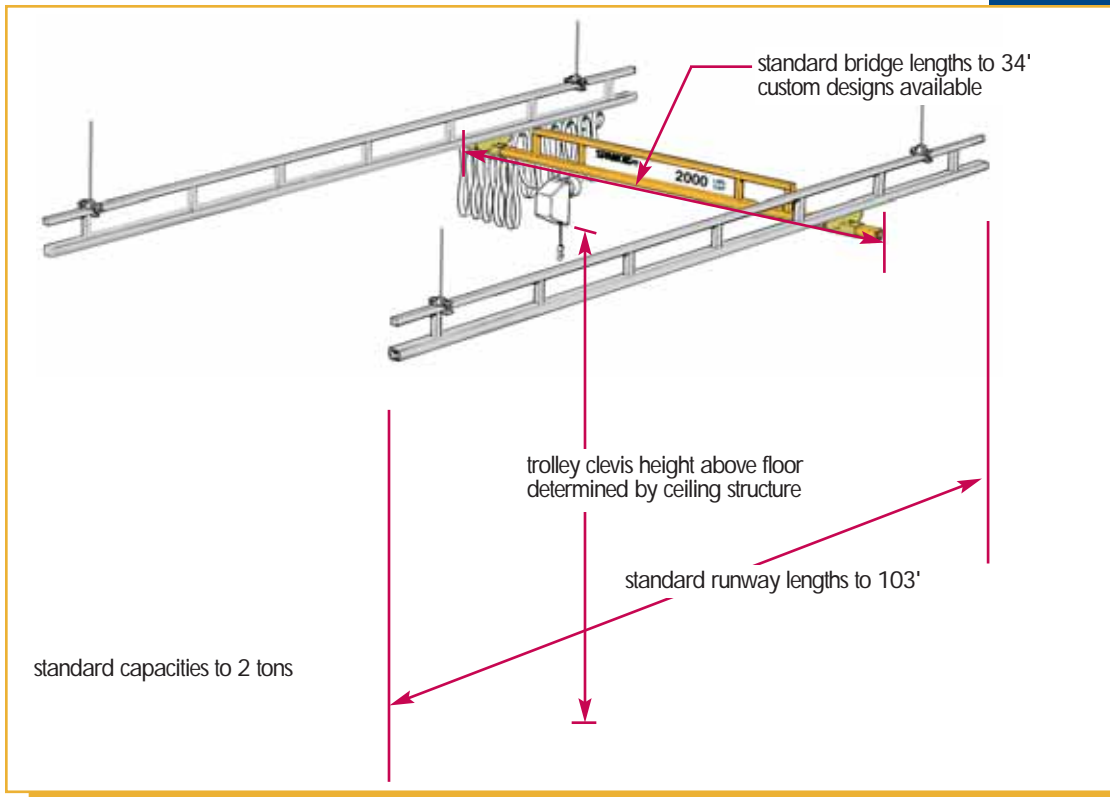

*Pre-engineered  
system kit.  
Everything supplied  
except hoist and  
sway bracing.*

### **DETERMINING CAPACITY, WIDTH, LENGTH, AND HEIGHT**

- **Capacity:** Load weights should be predetermined in order to avoid buying extra, unneeded capacity. Bridge dead weight will add more weight to the load the operator will be moving.
- **Width:** Bridge span is the length of a bridge between centers of two runways. SPANCO's standard design provides a standard bridge overhang of 12 in. on each end beyond the runway centerline. Bridge length is the overall length.
- **Length:** Runway length is determined by the length of a specific area requiring coverage. Runways are supported on maximum 20, 25, or 30 ft. support centers. Plain track runways are supported every 6 ft. for 400, 500, 600, and 900 series and every 9 ft. for 700 series.
- **Height:** In order to attain minimal resistance, it is recommended that the trolley clevis height be kept as low as possible, with practical consideration given to minimum headroom requirements. Height is measured from the floor to the trolley clevis from which a hoist is suspended.



# CEILING MOUNTED WORKSTATION BRIDGE CRANES



## EASY INSTALLATION AND MODULAR DESIGN

- **Pre-engineered modular design** allows for easy relocation and/or expansion by simply adding runway sections and additional bridges.

- **Splice joints** connect the track sections and are supplied complete with vertical and horizontal adjustment screws, facilitating precise alignment of the track sections.



- **Trussed splice joints** connect the top chord of the truss and link track sections for precise alignment.



*SPANCO enclosed track workstations meet or exceed ANSI B30.11 standards for monorails and underhung cranes.*

## CHOICE OF PAINT FINISHES

*All runways are painted with SPANCO's Standard Grey enamel or optional "Ford Blue."*

*All bridges are painted SPANCO Yellow.*



## DESIGN FACTORS

- **Nameplate bridge capacity** represents the rated load on the hoist hook. The load rating of a hoist shall not exceed the bridge rating. SPANCO's design includes an allowance of 15% of nameplate capacity for dead weight of the trolley and hoist. An additional allowance of 25% of nameplate capacity is also included for impact.



## SERVICE FACTOR

All SPANCO workstation cranes are designed for frequent usage *heavy service* as defined:

- System or equipment is used where **operational time is up to 100% of the work period and lifted load is at 50% or below** rated capacity.
- System or equipment is used where **operational time is less than 50% of work period and lifted load is greater than 50%** of rated capacity.
- **Applications involving vacuums, magnets, or other high impact lifters** are considered severe usage *continuous service* and require special design considerations. Please contact factory for special design pricing.
- Consult factory for usage other than moderate and all instances of high cycle rates or high impact applications such as high speed air or electric hoists, vacuum lifters, or magnets. **FACTORY MUST APPROVE ALL SUCH APPLICATIONS.**



# CETILING MOUNTED WORKSTATION BRIDGE CRANES

## SYSTEM OPTIONS

### Mixed Capacity Systems

- Maximize system capability and efficiency by utilizing heavier capacity runways and smaller capacity, multiple bridges.

- Example: Using a 2,000 lb. capacity runway system, two 1,000 lb. or four 500 lb. bridges can operate within the same runway support centers.

### Bridge Buffers

- Roll in the runway tracks between two crane bridges restricting the distance they can travel towards each other, to avoid overloading the runway.

### Intermediate Crane End Stops

- Additional through-bolted end stops can be installed in the runway tracks at runway support centers to prevent more than one bridge crane from operating within a set of support centers.

### Tractor Drives

- Power bridge or trolley and hoist travel on straight 600, 700, or 900 series track (1000 to 4000 lb. capacities) runways or monorails.
- 208 to 575 volts, three phase, 60 hertz, electric operation, air driven also available.
- Standard single speeds, 34, 50, and 75 F.P.M. Other speeds available.



Bridge Buffer





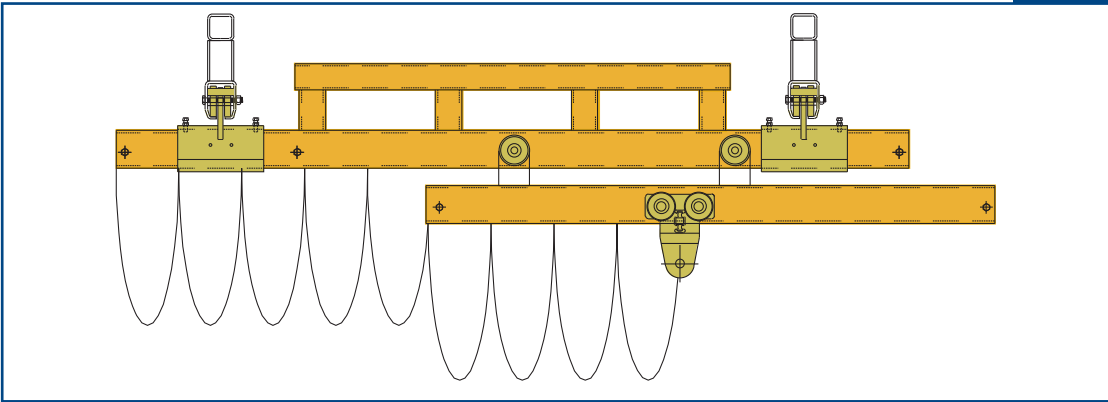

**TELESCOPING  
SYSTEM**

### Telescoping Bridges

- Provide extended reach to areas beyond a column or under mezzanines or shelving; a neighboring workstation; or into a specific area or opening requiring coverage.
- Steel anti-kickup wheels prevent bridge binding, ensuring smooth movement.
- Range in capacities up to 2000 lb. For specific applications, consult factory for an engineered solution.

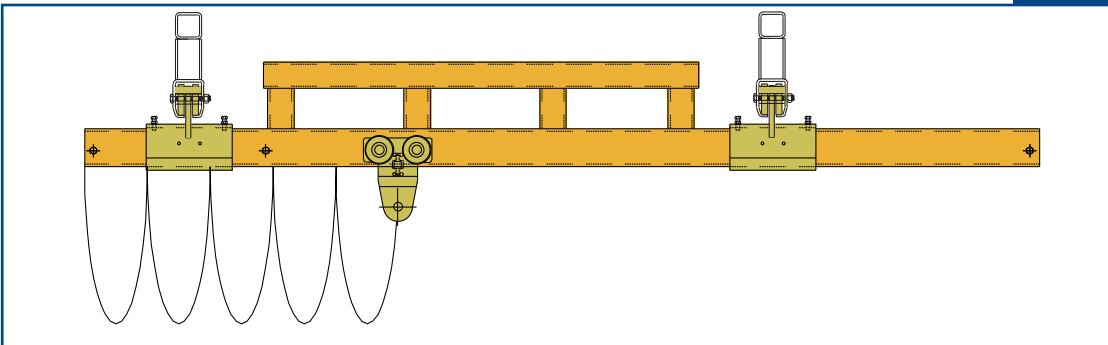

**CANTILEVERED  
SYSTEM**

### Cantilevered Bridges

- One or both ends of the crane bridge can be cantilevered beyond the standard 12 in. overhang in order to cover a wider area.
- For specific applications, consult factory for an engineered solution.

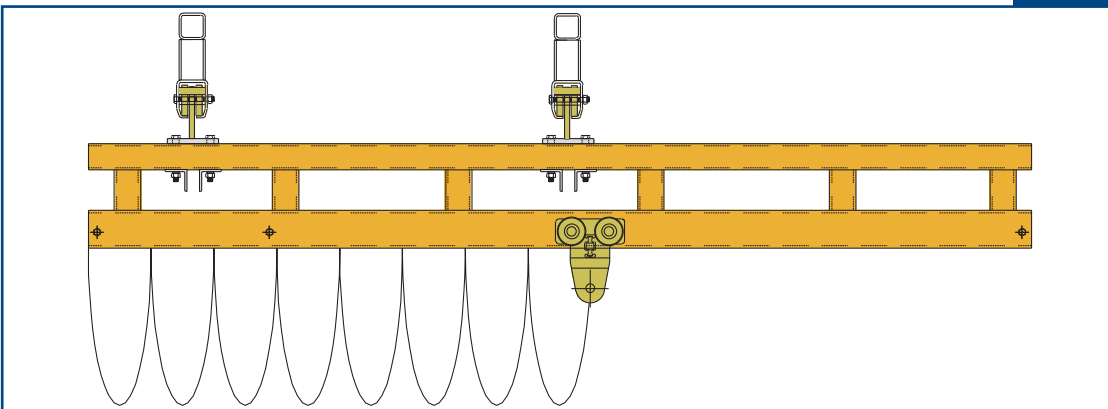

**TRUSSED  
CANTILEVERED  
SYSTEM**

# COMPONENTS WORKSTATION BRIDGE CRANES

## 1 END STOP BUMPER

- Through bolted to the track.
- Resilient rubber bumper increases impact resistance.
- Standard on all systems.

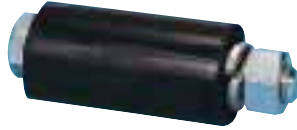

1 END STOP BUMPER

## 2 CABLE/HOSE TROLLEYS

- Utilized on powered hoist systems for conveying the power supply flat cable or round air hose from the static source to the powered hoist.
- Four wheels ensure smooth movement.
- Pivoting trolley clevis provides swiveling action for round air hose.
- Standard on all systems.



2 CABLE/HOSE TROLLEY

## 3 FESTOON SECTION

- Supplied to attach to the end of one runway to supply a stack-up section for the cable/hose trolleys.
- Allows complete end to end bridge travel.
- Standard on all systems.

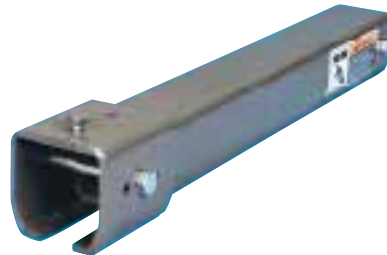

3 FESTOON SECTION

## 4 END TRUCK

- Provide smooth running connection between the bridge crane and runway track.
- Placement of horizontal steel wheels on either end of the end truck guards against "crabbing action" caused by non-parallel track profile, ensuring free movement.
- End trucks are designed to ANSI B30.11 specifications for underhung bridge cranes.



4 END TRUCK



5 HOIST TROLLEY

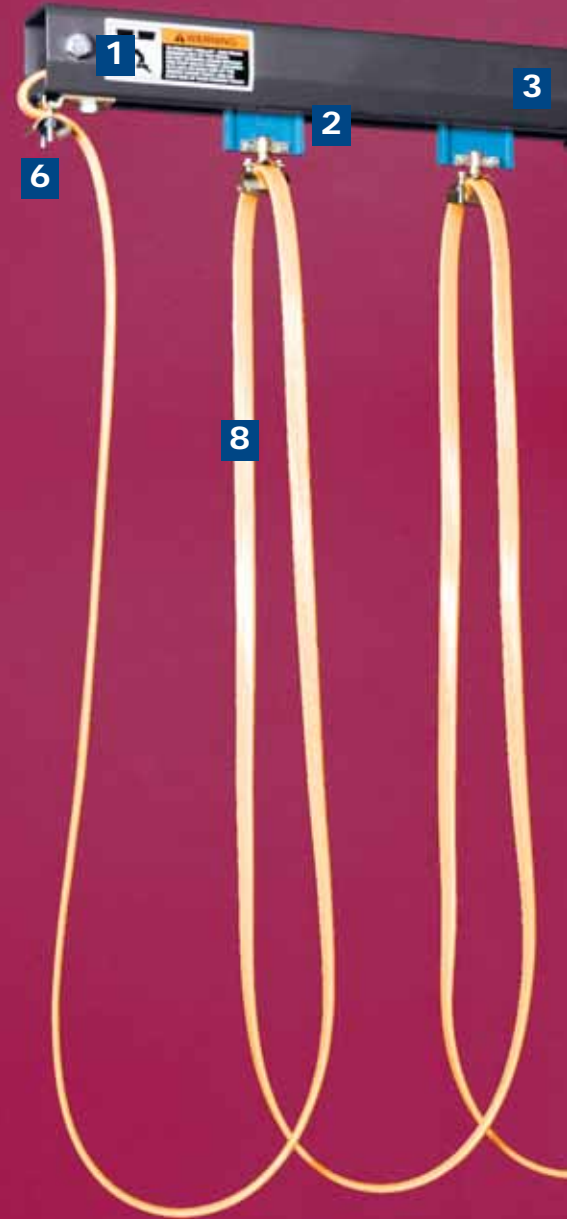

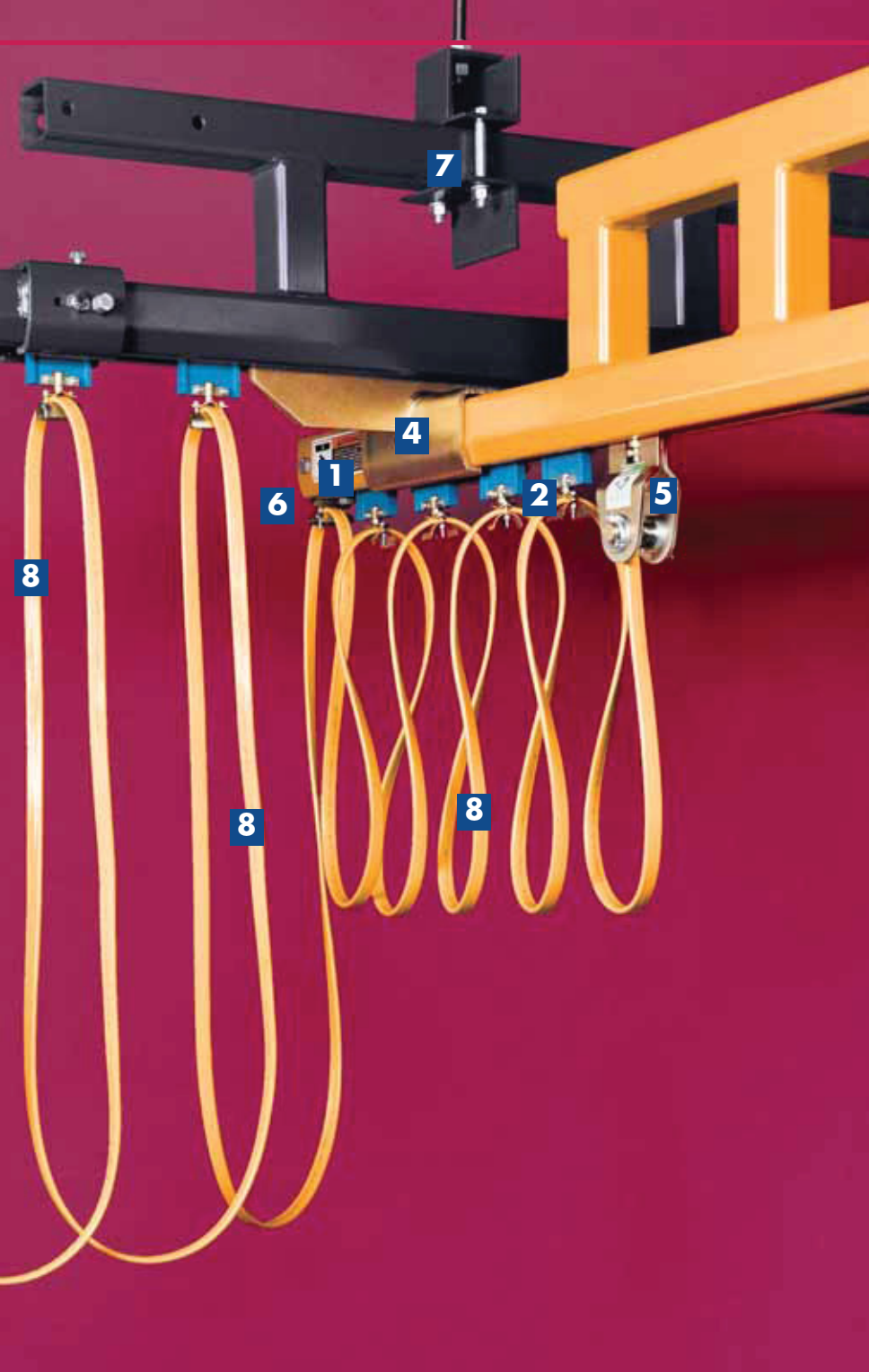

### 5 HOIST TROLLEY

- Connection between lifting device and bridge.
- Fabricated from precision cut steel plate.
- Trolleys are designed to ANSI B30.11 specifications for underhung bridge cranes.

### 6 CABLE/HOSE CLAMPS

- Fitted at one end of the runway and one end of the bridge.
- Utilized where power feed is required.

### 7 HANGER ASSEMBLY

- Standard tie rod support assembly. (See next page for more details.)

## FESTOONING SYSTEMS

### 8 FLAT CABLE

(four wire)

- Supplied with all systems.
- Optional, various sized air hoses available.

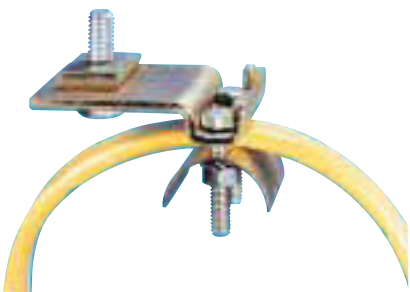

6 CABLE/HOSE CLAMP

## RUNWAY SUPPORT SYSTEMS

# CEILING MOUNTED WORKSTATION BRIDGE CRANES

### HANGER ASSEMBLY Tie Rod Plain Track Runway



### Tie Rod Hanger Assembly- Plain Track Runway

Standard hanger assembly for plain track systems. Includes:

- Adjustable roof beam clamp providing secure fit to horizontal beams only. Flange widths range from 2 1/4 in. to 8 in., and a maximum flange thickness of 7/16". Alternate clamps can be provided, upon request, for larger beams or for sloped beams (not horizontal).
- Standard 12 in. hanger rod. (Longer as required)
- Plain track support bracket.

### HANGER ASSEMBLY Tie Rod Trussed Track Runway



### Tie Rod Hanger Assembly- Trussed Track Runway

Standard hanger assembly for trussed track systems. Includes:

- Adjustable roof beam clamp providing secure fit to horizontal beams only. Flange widths range from 2 1/4 in. to 8 in., and a maximum flange thickness of 7/16". Alternate clamps can be provided, upon request, for larger beams or for sloped beams (not horizontal).
- Standard 12 in. hanger rod. (Longer as required)
- Trussed track support bracket.
- Lateral bracing required by others.

*SPANCO recommends consulting a qualified professional architect or engineer in your local area to determine your building support adequacy. Considerations include your geographical region, snowfall, seismic loading, etc.*

### Sway Bracing

- Required on all tie rod supported systems to ensure maximum runway rigidity.
- Sway brace clip attaches to standard rod and track clamp. Fits 1 in. diameter, schedule 40 pipe at a 45° angle.
- 1 inch pipe supplied by others.



### SWAY BRACING

*(Pipe Clamp optional. Pipe supplied by others.)*

### Flush Clamp- Cross Mount

- Optional hanger assembly attaching plain track to support steel. Fabricated from structural plate equipped with Grade 5 bolts and beam clips. Can only be used with a plain track bridge.
- Care should be taken to ensure adequate bridge clearance.



### FLUSH CLAMP

*Cross Mount*

### Flush Clamp- Parallel Mount

- Optional hanger assembly attaching plain track to support steel. Fabricated from structural plate equipped with two Grade 5 bolts and beam clips.
- Care should be taken to ensure adequate bridge clearance.

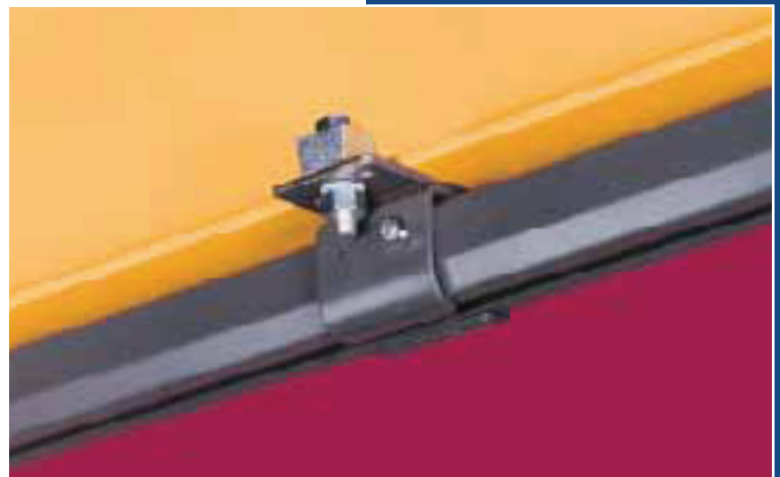

### FLUSH CLAMP *Parallel Mount*

# CEILING MOUNTED WORKSTATION BRIDGE CRANES

## SPECIFICATION CHARTS

SPANCO ceiling mounted bridge crane dimensional charts are organized according to the length of the maximum support centers for each runway. Generally, considering the following points is helpful for determining specific runway support centers:

- The size of the building or specific area requiring coverage: Will the system cover the full building perimeter or a smaller specific area within a building?
- Location of fixed structures such as machinery, building columns, overhead lighting, and fixtures.
- Specific logistics of the area requiring coverage: Is the system moving material to an assembly line, into storage, or from one workstation to another?

### CONSIDERATIONS FOR PLAIN TRACK

- Maximum runway support centers are 6 feet for 400, 500, 600, and 900 series track. Support centers are 9 feet for 700 series track.
- Specific headroom requirements: Runways can be flush mounted to overhead building steel if conditions permit, allowing the lowest possible headroom constraint.

### CONSIDERATIONS FOR TRUSSED TRACK

- Maximum runway support centers are 20, 25, and 30 feet.
- Specific headroom requirements: 20 ft. runway support centers allow for runway trusses with the shortest depth, maximizing headroom space under the hoist.

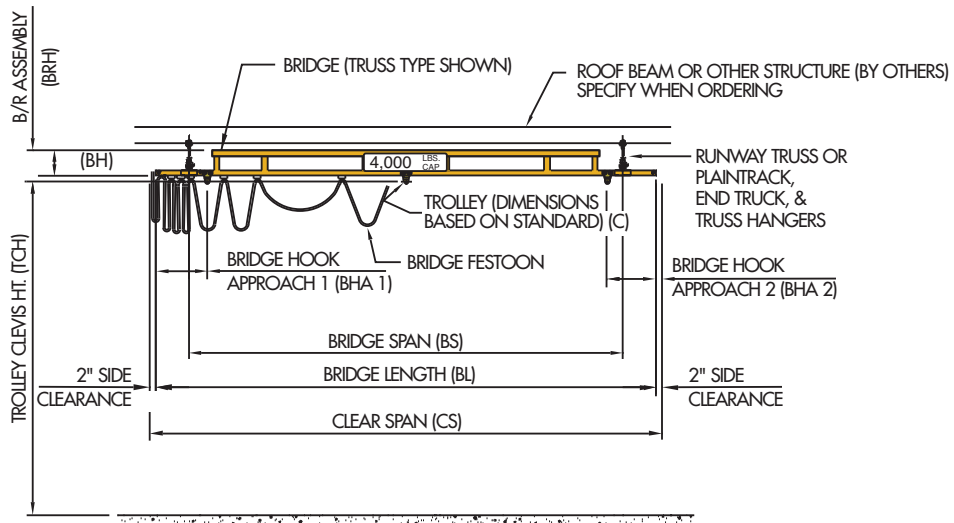

## TRUSSED TRACK RUNWAY

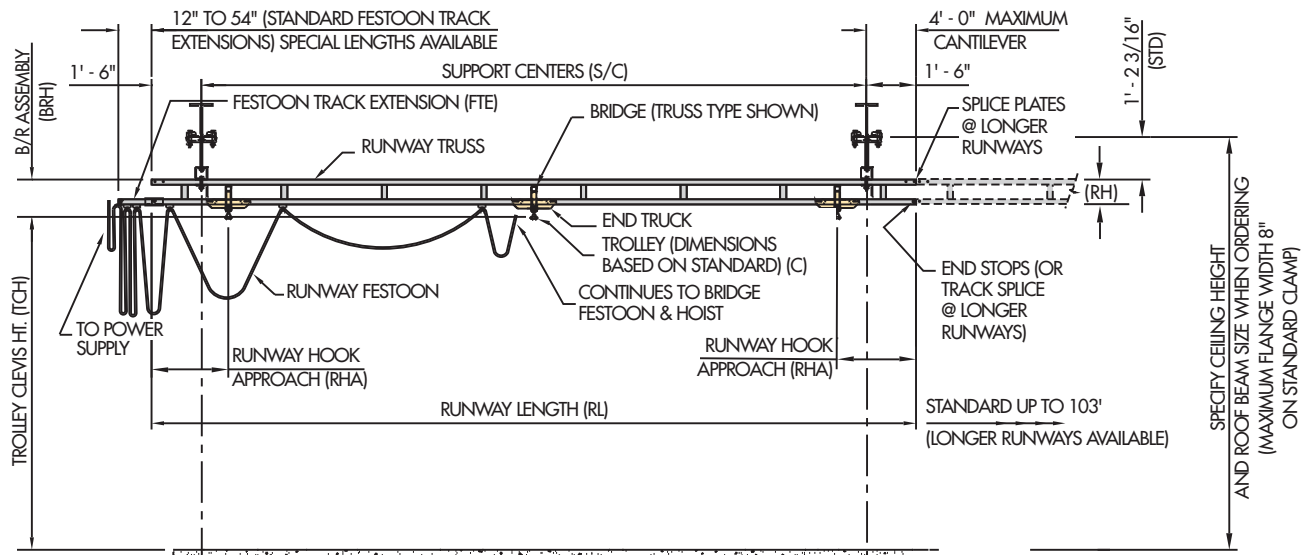

## PLAIN TRACK RUNWAY

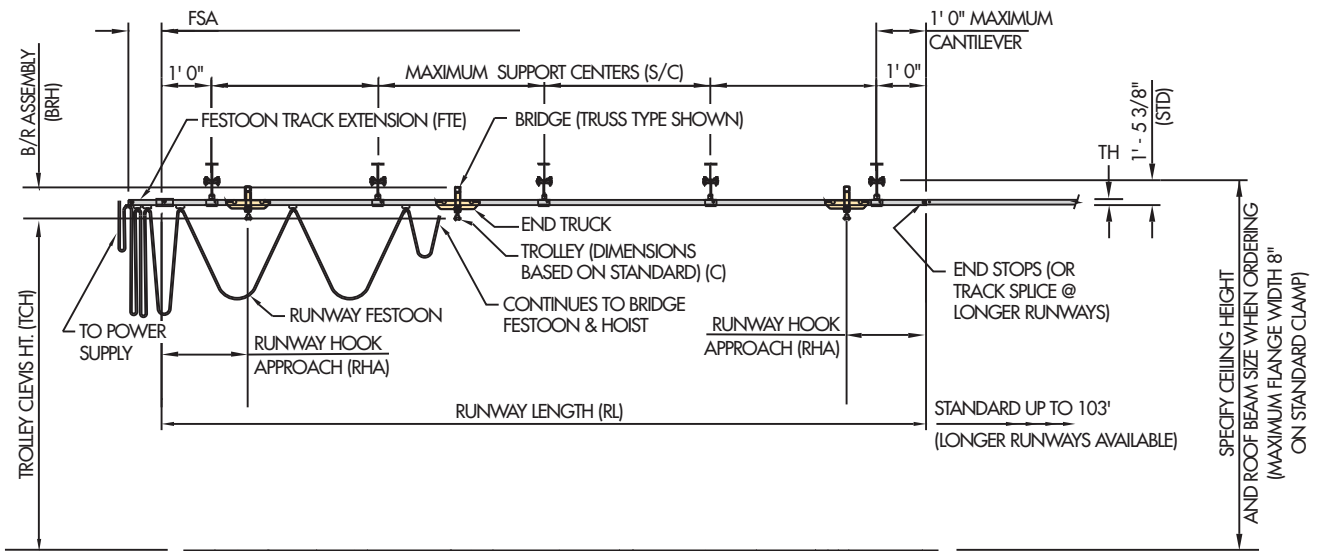

C = TROLLEY DIMENSION (bottom of the bridge to trolley clevis) BH = BRIDGE HEIGHT RH = RUNWAY HEIGHT

## CEILING MOUNTED WORKSTATION BRIDGE CRANES END APPROACH

| HOOK APPROACH DATA |            |        |        |            |        |          |            |        |          |            |        |         |            |        |          |            |         |           |
|--------------------|------------|--------|--------|------------|--------|----------|------------|--------|----------|------------|--------|---------|------------|--------|----------|------------|---------|-----------|
| SYSTEM DATA        | 300 SERIES |        |        | 400 SERIES |        |          | 500 SERIES |        |          | 600 SERIES |        |         | 700 SERIES |        |          | 900 SERIES |         |           |
|                    | BRIDGE     |        | RUNWAY | BRIDGE     |        | RUNWAY   | BRIDGE     |        | RUNWAY   | BRIDGE     |        | RUNWAY  | BRIDGE     |        | RUNWAY   | BRIDGE     |         | RUNWAY    |
|                    | BL         | BHA1   | BHA2   | RHA        | BHA1   | BHA2     | RHA        | BHA1   | BHA2     | RHA        | BHA1   | BHA2    | RHA        | BHA1   | BHA2     | RHA        | BHA1    | BHA2      |
| 8'                 | 8 1/8"     | 2 7/8" | 8"     | 10 1/2"    | 3 1/4" | 9 3/4"   | 18 5/8"    | 3 5/8" | 10 5/16" | 20"        | 4 1/8" | 11 1/4" | 22 1/8"    | 5 3/8" | 13 7/16" | 38 1/8"    | 21 3/8" | 33 15/16" |
| 10'                | 10 3/4"    | 2 7/8" | 8"     | 14"        | 3 1/4" | 9 3/4"   | 18 5/8"    | 3 5/8" | 10 5/16" | 20"        | 4 1/8" | 11 1/4" | 22 1/8"    | 5 3/8" | 13 7/16" | 38 1/8"    | 21 3/8" | 33 15/16" |
| 15'                | 13 3/8"    | 2 7/8" | 8"     | 17 1/2"    | 3 1/4" | 9 3/4"   | 18 5/8"    | 3 5/8" | 10 5/16" | 20"        | 4 1/8" | 11 1/4" | 22 1/8"    | 5 3/8" | 13 7/16" | 38 1/8"    | 21 3/8" | 33 15/16" |
| 20'                | 18 5/8"    | 2 7/8" | 8"     | 24 1/2"    | 3 1/4" | 9 3/4"   | 25 1/2"    | 3 5/8" | 10 5/16" | 25 7/8"    | 4 1/8" | 11 1/4" | 27"        | 5 3/8" | 13 7/16" | 43"        | 21 3/8" | 33 15/16" |
| 23'                | N/A        | N/A    | N/A    | 28"        | 3 1/4" | 9 3/4"   | 29"        | 3 5/8" | 10 5/16" | 29 3/8"    | 4 1/8" | 11 1/4" | 30 1/2"    | 5 3/8" | 13 7/16" | 46 1/2"    | 21 3/8" | 33 15/16" |
| 28'                | N/A        | N/A    | N/A    | 31 1/2"    | 3 1/4" | 19 5/16" | 32 1/2"    | 3 5/8" | 19 7/8"  | 32 7/8"    | 4 1/8" | 20 3/4" | 34"        | 5 3/8" | 29 3/16" | 50"        | 21 3/8" | 33 15/16" |
| 34'                | N/A        | N/A    | N/A    | N/A        | N/A    | N/A      | 43"        | 3 5/8" | 19 7/8"  | 43 3/8"    | 4 1/8" | 20 3/4" | 44 1/2"    | 5 3/8" | 29 3/16" | N/A        | N/A     | N/A       |

Applies to all runway lengths up to 103'

### SYSTEM SPECIFICATIONS FOR CEILING MOUNTED KITS

SPANCO Ceiling Mounted Workstation Bridge Crane kits include:

#### BRIDGE KITS

1. Plain bridge, tube reinforced bridge, or trussed bridge as required
2. Hoist trolley
3. Bridge end stops
4. Festoon cable with trolleys
5. End trucks

#### RUNWAY KITS

1. Hangers
  2. Runway end stops
  3. Festoon cable with trolleys
  4. Standard festoon track extension
  5. Plain or trussed runways
- Ceiling mounted system kits include appropriate number of hanger rods, hangers, adjustable beam clamps, and track support brackets.
  - Ceiling mounted system kits do not include hoist.
  - All ceiling mounted systems must be properly braced to existing structure using proper sway bracing. To achieve desired rigidity for specific application, SPANCO recommends consulting a professional architect or engineer in your local area to satisfy all codes and ordinances.
  - Dimensions shown are approximate and subject to change without notice. All catalog dimensions are developed using standard components for the spans and capacities required. Substitution of optional trolleys or other components will affect certain dimensions. If specific clearances are required, specify at time of order.

| <span style="font-weight: bold; font-size: 1.2em;">BRIDGE CRANE KITS &amp; CEILING MOUNTED KITS</span> |                                 |
|--|---------------------------------|
| CUSTOMER:  | STANDARD SUPPORT CENTERS (S/C): |
| TRACK SERIES:                      CAPACITY:   | RUNWAY SUPPORT CENTERS (S/C1):  |
| NUMBER OF UNITS:   | RUNWAY SUPPORT CENTERS (S/C2):  |
| TROLLEY CLEVIS HT. (TCH):  | RUNWAY SUPPORT CENTERS (S/C3):  |
| CEILING HEIGHT:  | RUNWAY SUPPORT CENTERS (S/C4):  |
| BRIDGE / RUNWAY  | RUNWAY SUPPORT CENTERS (S/C5):  |
| MODEL NUMBER:  | HANGER ROD LENGTH:              |
| BRIDGE LENGTH (BL):  | ELECTRICAL REQUIREMENTS:        |
| CLEAR SPAN (CS):   | FESTOON TRACK EXTENSION (FTE):  |
| OVERALL RUNWAY LENGTH (RL):  | FESTOON CABLE LENGTH (FCL):     |





**6' - 0" / 20' - 0" MAXIMUM SUPPORT CENTERS**

**500 LB. CAPACITY**

**8' - 10' - 15' - 20' - 23' - 28' - 34' BRIDGE LENGTH**

| TRUSSED TRACK RUNWAY SYSTEMS |        |                 |            |           |                    |           |    |              |      |                |           | PLAIN TRACK RUNWAY SYSTEMS |        |                    |    |    |     |    |   |    |
|------------------------------|--------|-----------------|------------|-----------|--------------------|-----------|----|--------------|------|----------------|-----------|----------------------------|--------|--------------------|----|----|-----|----|---|----|
| SYSTEM DATA                  |        | MODEL NUMBER    |            |           | BRIDGE/RUNWAY DATA |           |    | FESTOON DATA |      |                |           | MODEL NUMBER               |        | BRIDGE/RUNWAY DATA |    |    |     |    |   |    |
| BL                           | RL     | CMT             | BL         | RL        | TS                 | BRH       | BH | C            | RH   | QTY            | FTE       | FCL                        | CMP    | BL                 | RL | TS | BRH | BH | C | TH |
| 8'                           | 11'-6" | CMT-8-11.5-500  | 1'-4 3/16" | 2 3/8"    | 2 5/8"             | 10"       | 4  | 12"          | 28'  | CMP-8-11-500   | 8 9/16"   | 2 3/8"                     | 2 5/8" | 2 3/8"             |    |    |     |    |   |    |
|                              | 23'    | CMT-8-23-500    | 1'-4 3/16" | 2 3/8"    | 2 5/8"             | 10"       | 5  | 12"          | 41'  | CMP-8-23-500   | 8 9/16"   | 2 3/8"                     | 2 5/8" | 2 3/8"             |    |    |     |    |   |    |
|                              | 33'    | CMT-8-33-500    | 1'-4 3/16" | 2 3/8"    | 2 5/8"             | 10"       | 7  | 24"          | 52'  | CMP-8-33-500   | 8 9/16"   | 2 3/8"                     | 2 5/8" | 2 3/8"             |    |    |     |    |   |    |
|                              | 43'    | CMT-8-43-500    | 1'-4 3/16" | 2 3/8"    | 2 5/8"             | 10"       | 9  | 24"          | 62'  | CMP-8-43-500   | 8 9/16"   | 2 3/8"                     | 2 5/8" | 2 3/8"             |    |    |     |    |   |    |
|                              | 53'    | CMT-8-53-500    | 1'-4 3/16" | 2 3/8"    | 2 5/8"             | 10"       | 10 | 36"          | 74'  | CMP-8-53-500   | 8 9/16"   | 2 3/8"                     | 2 5/8" | 2 3/8"             |    |    |     |    |   |    |
|                              | 63'    | CMT-8-63-500    | 1'-4 3/16" | 2 3/8"    | 2 5/8"             | 10"       | 12 | 36"          | 85'  | CMP-8-63-500   | 8 9/16"   | 2 3/8"                     | 2 5/8" | 2 3/8"             |    |    |     |    |   |    |
|                              | 83'    | CMT-8-83-500    | 1'-4 3/16" | 2 3/8"    | 2 5/8"             | 10"       | 15 | 54"          | 107' | CMP-8-83-500   | 8 9/16"   | 2 3/8"                     | 2 5/8" | 2 3/8"             |    |    |     |    |   |    |
|                              | 103'   | CMT-8-103-500   | 1'-4 3/16" | 2 3/8"    | 2 5/8"             | 10"       | 19 | 54"          | 129' | CMP-8-103-500  | 8 9/16"   | 2 3/8"                     | 2 5/8" | 2 3/8"             |    |    |     |    |   |    |
| 10'                          | 11'-6" | CMT-10-11.5-500 | 1'-4 3/16" | 6 3/8"    | 2 5/8"             | 10"       | 5  | 12"          | 30'  | CMP-10-11-500  | 9"        | 6 3/8"                     | 2 5/8" | 2 3/8"             |    |    |     |    |   |    |
|                              | 23'    | CMT-10-23-500   | 1'-4 3/16" | 6 3/8"    | 2 5/8"             | 10"       | 6  | 12"          | 43'  | CMP-10-23-500  | 9"        | 6 3/8"                     | 2 5/8" | 2 3/8"             |    |    |     |    |   |    |
|                              | 33'    | CMT-10-33-500   | 1'-4 3/16" | 6 3/8"    | 2 5/8"             | 10"       | 8  | 24"          | 54'  | CMP-10-33-500  | 9"        | 6 3/8"                     | 2 5/8" | 2 3/8"             |    |    |     |    |   |    |
|                              | 43'    | CMT-10-43-500   | 1'-4 3/16" | 6 3/8"    | 2 5/8"             | 10"       | 10 | 24"          | 64'  | CMP-10-43-500  | 9"        | 6 3/8"                     | 2 5/8" | 2 3/8"             |    |    |     |    |   |    |
|                              | 53'    | CMT-10-53-500   | 1'-4 3/16" | 6 3/8"    | 2 5/8"             | 10"       | 11 | 36"          | 76'  | CMP-10-53-500  | 9"        | 6 3/8"                     | 2 5/8" | 2 3/8"             |    |    |     |    |   |    |
|                              | 63'    | CMT-10-63-500   | 1'-4 3/16" | 6 3/8"    | 2 5/8"             | 10"       | 13 | 36"          | 87'  | CMP-10-63-500  | 9"        | 6 3/8"                     | 2 5/8" | 2 3/8"             |    |    |     |    |   |    |
|                              | 83'    | CMT-10-83-500   | 1'-4 3/16" | 6 3/8"    | 2 5/8"             | 10"       | 16 | 54"          | 109' | CMP-10-83-500  | 9"        | 6 3/8"                     | 2 5/8" | 2 3/8"             |    |    |     |    |   |    |
|                              | 103'   | CMT-10-103-500  | 1'-4 3/16" | 6 3/8"    | 2 5/8"             | 10"       | 20 | 54"          | 131' | CMP-10-103-500 | 9"        | 6 3/8"                     | 2 5/8" | 2 3/8"             |    |    |     |    |   |    |
| 15'                          | 23'    | CMT-15-23-500   | 1'-4 3/16" | 10"       | 2 5/8"             | 10"       | 7  | 12"          | 49'  | CMP-15-23-500  | 1'-0 5/8" | 10"                        | 2 5/8" | 2 3/8"             |    |    |     |    |   |    |
|                              | 33'    | CMT-15-33-500   | 1'-4 3/16" | 10"       | 2 5/8"             | 10"       | 9  | 24"          | 60'  | CMP-15-33-500  | 1'-0 5/8" | 10"                        | 2 5/8" | 2 3/8"             |    |    |     |    |   |    |
|                              | 43'    | CMT-15-43-500   | 1'-4 3/16" | 10"       | 2 5/8"             | 10"       | 11 | 24"          | 70'  | CMP-15-43-500  | 1'-0 5/8" | 10"                        | 2 5/8" | 2 3/8"             |    |    |     |    |   |    |
|                              | 53'    | CMT-15-53-500   | 1'-4 3/16" | 10"       | 2 5/8"             | 10"       | 12 | 36"          | 82'  | CMP-15-53-500  | 1'-0 5/8" | 10"                        | 2 5/8" | 2 3/8"             |    |    |     |    |   |    |
|                              | 63'    | CMT-15-63-500   | 1'-4 3/16" | 10"       | 2 5/8"             | 10"       | 14 | 36"          | 93'  | CMP-15-63-500  | 1'-0 5/8" | 10"                        | 2 5/8" | 2 3/8"             |    |    |     |    |   |    |
|                              | 83'    | CMT-15-83-500   | 1'-4 3/16" | 10"       | 2 5/8"             | 10"       | 17 | 54"          | 115' | CMP-15-83-500  | 1'-0 5/8" | 10"                        | 2 5/8" | 2 3/8"             |    |    |     |    |   |    |
| 20'                          | 23'    | CMT-20-23-500   | 1'-4 3/16" | 10"       | 2 5/8"             | 10"       | 9  | 12"          | 54'  | CMP-20-23-500  | 1'-0 5/8" | 10"                        | 2 5/8" | 2 3/8"             |    |    |     |    |   |    |
|                              | 33'    | CMT-20-33-500   | 1'-4 3/16" | 10"       | 2 5/8"             | 10"       | 11 | 24"          | 65'  | CMP-20-33-500  | 1'-0 5/8" | 10"                        | 2 5/8" | 2 3/8"             |    |    |     |    |   |    |
|                              | 43'    | CMT-20-43-500   | 1'-4 3/16" | 10"       | 2 5/8"             | 10"       | 13 | 24"          | 75'  | CMP-20-43-500  | 1'-0 5/8" | 10"                        | 2 5/8" | 2 3/8"             |    |    |     |    |   |    |
|                              | 53'    | CMT-20-53-500   | 1'-4 3/16" | 10"       | 2 5/8"             | 10"       | 14 | 36"          | 87'  | CMP-20-53-500  | 1'-0 5/8" | 10"                        | 2 5/8" | 2 3/8"             |    |    |     |    |   |    |
|                              | 63'    | CMT-20-63-500   | 1'-4 3/16" | 10"       | 2 5/8"             | 10"       | 16 | 36"          | 98'  | CMP-20-63-500  | 1'-0 5/8" | 10"                        | 2 5/8" | 2 3/8"             |    |    |     |    |   |    |
|                              | 83'    | CMT-20-83-500   | 1'-4 3/16" | 10"       | 2 5/8"             | 10"       | 19 | 54"          | 120' | CMP-20-83-500  | 1'-0 5/8" | 10"                        | 2 5/8" | 2 3/8"             |    |    |     |    |   |    |
| 23'                          | 23'    | CMT-23-23-500   | 1'-4 3/16" | 10"       | 2 5/8"             | 10"       | 10 | 12"          | 58'  | CMP-23-23-500  | 1'-0 5/8" | 10"                        | 2 5/8" | 2 3/8"             |    |    |     |    |   |    |
|                              | 33'    | CMT-23-33-500   | 1'-4 3/16" | 10"       | 2 5/8"             | 10"       | 12 | 24"          | 69'  | CMP-23-33-500  | 1'-0 5/8" | 10"                        | 2 5/8" | 2 3/8"             |    |    |     |    |   |    |
|                              | 43'    | CMT-23-43-500   | 1'-4 3/16" | 10"       | 2 5/8"             | 10"       | 14 | 24"          | 79'  | CMP-23-43-500  | 1'-0 5/8" | 10"                        | 2 5/8" | 2 3/8"             |    |    |     |    |   |    |
|                              | 53'    | CMT-23-53-500   | 1'-4 3/16" | 10"       | 2 5/8"             | 10"       | 15 | 36"          | 91'  | CMP-23-53-500  | 1'-0 5/8" | 10"                        | 2 5/8" | 2 3/8"             |    |    |     |    |   |    |
|                              | 63'    | CMT-23-63-500   | 1'-4 3/16" | 10"       | 2 5/8"             | 10"       | 17 | 36"          | 102' | CMP-23-63-500  | 1'-0 5/8" | 10"                        | 2 5/8" | 2 3/8"             |    |    |     |    |   |    |
|                              | 83'    | CMT-23-83-500   | 1'-4 3/16" | 10"       | 2 5/8"             | 10"       | 20 | 54"          | 124' | CMP-23-83-500  | 1'-0 5/8" | 10"                        | 2 5/8" | 2 3/8"             |    |    |     |    |   |    |
| 28'                          | 23'    | CMT-28-23-500   | 1'-6"      | 1'-0 3/8" | 2 5/8"             | 10"       | 11 | 12"          | 63'  | CMP-28-23-500  | 1'-3"     | 1'-0 3/8"                  | 2 5/8" | 2 3/8"             |    |    |     |    |   |    |
|                              | 33'    | CMT-28-33-500   | 1'-6"      | 1'-0 3/8" | 2 5/8"             | 10"       | 13 | 24"          | 74'  | CMP-28-33-500  | 1'-3"     | 1'-0 3/8"                  | 2 5/8" | 2 3/8"             |    |    |     |    |   |    |
|                              | 43'    | CMT-28-43-500   | 1'-6"      | 1'-0 3/8" | 2 5/8"             | 10"       | 15 | 24"          | 85'  | CMP-28-43-500  | 1'-3"     | 1'-0 3/8"                  | 2 5/8" | 2 3/8"             |    |    |     |    |   |    |
|                              | 53'    | CMT-28-53-500   | 1'-6"      | 1'-0 3/8" | 2 5/8"             | 10"       | 16 | 36"          | 96'  | CMP-28-53-500  | 1'-3"     | 1'-0 3/8"                  | 2 5/8" | 2 3/8"             |    |    |     |    |   |    |
|                              | 63'    | CMT-28-63-500   | 1'-6"      | 1'-0 3/8" | 2 5/8"             | 10"       | 18 | 36"          | 107' | CMP-28-63-500  | 1'-3"     | 1'-0 3/8"                  | 2 5/8" | 2 3/8"             |    |    |     |    |   |    |
|                              | 83'    | CMT-28-83-500   | 1'-6"      | 1'-0 3/8" | 2 5/8"             | 10"       | 21 | 54"          | 129' | CMP-28-83-500  | 1'-3"     | 1'-0 3/8"                  | 2 5/8" | 2 3/8"             |    |    |     |    |   |    |
| 34'                          | 23'    | CMT-34-23-500   | 1'-8 3/8"  | 1'-2 3/8" | 2 5/8"             | 1'-0 3/8" | 14 | 12"          | 70'  | CMP-34-23-500  | 1'-5"     | 1'-2 3/8"                  | 2 5/8" | 2 3/8"             |    |    |     |    |   |    |
|                              | 33'    | CMT-34-33-500   | 1'-8 3/8"  | 1'-2 3/8" | 2 5/8"             | 1'-0 3/8" | 16 | 24"          | 81'  | CMP-34-33-500  | 1'-5"     | 1'-2 3/8"                  | 2 5/8" | 2 3/8"             |    |    |     |    |   |    |
|                              | 43'    | CMT-34-43-500   | 1'-8 3/8"  | 1'-2 3/8" | 2 5/8"             | 1'-0 3/8" | 18 | 24"          | 91'  | CMP-34-43-500  | 1'-5"     | 1'-2 3/8"                  | 2 5/8" | 2 3/8"             |    |    |     |    |   |    |
|                              | 53'    | CMT-34-53-500   | 1'-8 3/8"  | 1'-2 3/8" | 2 5/8"             | 1'-0 3/8" | 19 | 36"          | 103' | CMP-34-53-500  | 1'-5"     | 1'-2 3/8"                  | 2 5/8" | 2 3/8"             |    |    |     |    |   |    |
|                              | 63'    | CMT-34-63-500   | 1'-8 3/8"  | 1'-2 3/8" | 2 5/8"             | 1'-0 3/8" | 21 | 36"          | 114' | CMP-34-63-500  | 1'-5"     | 1'-2 3/8"                  | 2 5/8" | 2 3/8"             |    |    |     |    |   |    |
|                              | 83'    | CMT-34-83-500   | 1'-8 3/8"  | 1'-2 3/8" | 2 5/8"             | 1'-0 3/8" | 24 | 54"          | 136' | CMP-34-83-500  | 1'-5"     | 1'-2 3/8"                  | 2 5/8" | 2 3/8"             |    |    |     |    |   |    |

20' 0" MAX. SUPPORT CENTERS

6' 0" MAX. SUPPORT CENTERS

Hoist not included.





| TRUSSED TRACK RUNWAY SYSTEMS |                |                 |           |          |                    |       |     |      |                |               |            | PLAIN TRACK RUNWAY SYSTEMS |         |                    |    |    |     |    |   |    |
|------------------------------|----------------|-----------------|-----------|----------|--------------------|-------|-----|------|----------------|---------------|------------|----------------------------|---------|--------------------|----|----|-----|----|---|----|
| SYSTEM DATA                  |                | MODEL NUMBER    |           |          | BRIDGE/RUNWAY DATA |       |     |      | FESTOON DATA   |               |            | MODEL NUMBER               |         | BRIDGE/RUNWAY DATA |    |    |     |    |   |    |
| BL                           | RL             | CMT             | BL        | RL       | TS                 | BRH   | BH  | C    | RH             | QTY           | FTE        | FCL                        | CMP     | BL                 | RL | TS | BRH | BH | C | TH |
| 8'                           | 11'-6"         | CMT-8-11.5-900  | 2'-6 3/4" | 4 5/16"  | 4 1/8"             | 1'-6" | 4   | 12"  | 28'            | CMP-8-11-900  | 1'-2 1/16" | 4 5/16"                    | 4 1/8"  | 4 5/16"            |    |    |     |    |   |    |
|                              | 23'            | CMT-8-23-900    | 2'-6 3/4" | 4 5/16"  | 4 1/8"             | 1'-6" | 5   | 12"  | 41'            | CMP-8-23-900  | 1'-2 1/16" | 4 5/16"                    | 4 1/8"  | 4 5/16"            |    |    |     |    |   |    |
|                              | 33'            | CMT-8-33-900    | 2'-6 3/4" | 4 5/16"  | 4 1/8"             | 1'-6" | 7   | 24"  | 52'            | CMP-8-33-900  | 1'-2 1/16" | 4 5/16"                    | 4 1/8"  | 4 5/16"            |    |    |     |    |   |    |
|                              | 43'            | CMT-8-43-900    | 2'-6 3/4" | 4 5/16"  | 4 1/8"             | 1'-6" | 9   | 24"  | 62'            | CMP-8-43-900  | 1'-2 1/16" | 4 5/16"                    | 4 1/8"  | 4 5/16"            |    |    |     |    |   |    |
|                              | 53'            | CMT-8-53-900    | 2'-6 3/4" | 4 5/16"  | 4 1/8"             | 1'-6" | 10  | 36"  | 74'            | CMP-8-53-900  | 1'-2 1/16" | 4 5/16"                    | 4 1/8"  | 4 5/16"            |    |    |     |    |   |    |
|                              | 63'            | CMT-8-63-900    | 2'-6 3/4" | 4 5/16"  | 4 1/8"             | 1'-6" | 12  | 36"  | 85'            | CMP-8-63-900  | 1'-2 1/16" | 4 5/16"                    | 4 1/8"  | 4 5/16"            |    |    |     |    |   |    |
|                              | 83'            | CMT-8-83-900    | 2'-6 3/4" | 4 5/16"  | 4 1/8"             | 1'-6" | 15  | 54"  | 107'           | CMP-8-83-900  | 1'-2 1/16" | 4 5/16"                    | 4 1/8"  | 4 5/16"            |    |    |     |    |   |    |
| 103'                         | CMT-8-103-900  | 2'-6 3/4"       | 4 5/16"   | 4 1/8"   | 1'-6"              | 19    | 54" | 129' | CMP-8-103-900  | 1'-2 1/16"    | 4 5/16"    | 4 1/8"                     | 4 5/16" |                    |    |    |     |    |   |    |
| 10'                          | 11'-6"         | CMT-10-11.5-900 | 2'-6 3/4" | 7 13/16" | 4 1/8"             | 1'-6" | 5   | 12"  | 30'            | CMP-10-11-900 | 1'-2 1/16" | 7 13/16"                   | 4 1/8"  | 4 5/16"            |    |    |     |    |   |    |
|                              | 23'            | CMT-10-23-900   | 2'-6 3/4" | 7 13/16" | 4 1/8"             | 1'-6" | 6   | 12"  | 43'            | CMP-10-23-900 | 1'-2 1/16" | 7 13/16"                   | 4 1/8"  | 4 5/16"            |    |    |     |    |   |    |
|                              | 33'            | CMT-10-33-900   | 2'-6 3/4" | 7 13/16" | 4 1/8"             | 1'-6" | 8   | 24"  | 54'            | CMP-10-33-900 | 1'-2 1/16" | 7 13/16"                   | 4 1/8"  | 4 5/16"            |    |    |     |    |   |    |
|                              | 43'            | CMT-10-43-900   | 2'-6 3/4" | 7 13/16" | 4 1/8"             | 1'-6" | 10  | 24"  | 64'            | CMP-10-43-900 | 1'-2 1/16" | 7 13/16"                   | 4 1/8"  | 4 5/16"            |    |    |     |    |   |    |
|                              | 53'            | CMT-10-53-900   | 2'-6 3/4" | 7 13/16" | 4 1/8"             | 1'-6" | 11  | 36"  | 76'            | CMP-10-53-900 | 1'-2 1/16" | 7 13/16"                   | 4 1/8"  | 4 5/16"            |    |    |     |    |   |    |
|                              | 63'            | CMT-10-63-900   | 2'-6 3/4" | 7 13/16" | 4 1/8"             | 1'-6" | 13  | 36"  | 87'            | CMP-10-63-900 | 1'-2 1/16" | 7 13/16"                   | 4 1/8"  | 4 5/16"            |    |    |     |    |   |    |
|                              | 83'            | CMT-10-83-900   | 2'-6 3/4" | 7 13/16" | 4 1/8"             | 1'-6" | 16  | 54"  | 109'           | CMP-10-83-900 | 1'-2 1/16" | 7 13/16"                   | 4 1/8"  | 4 5/16"            |    |    |     |    |   |    |
| 103'                         | CMT-10-103-900 | 2'-6 3/4"       | 7 13/16"  | 4 1/8"   | 1'-6"              | 20    | 54" | 131' | CMP-10-103-900 | 1'-2 1/16"    | 7 13/16"   | 4 1/8"                     | 4 5/16" |                    |    |    |     |    |   |    |
| 15'                          | 23'            | CMT-15-23-900   | 2'-6 3/4" | 1'-6"    | 4 1/8"             | 1'-6" | 7   | 12"  | 49'            | CMP-15-23-900 | 1'-10 1/8" | 1'-6"                      | 4 1/8"  | 4 5/16"            |    |    |     |    |   |    |
|                              | 33'            | CMT-15-33-900   | 2'-6 3/4" | 1'-6"    | 4 1/8"             | 1'-6" | 9   | 24"  | 60'            | CMP-15-33-900 | 1'-10 1/8" | 1'-6"                      | 4 1/8"  | 4 5/16"            |    |    |     |    |   |    |
|                              | 43'            | CMT-15-43-900   | 2'-6 3/4" | 1'-6"    | 4 1/8"             | 1'-6" | 11  | 24"  | 70'            | CMP-15-43-900 | 1'-10 1/8" | 1'-6"                      | 4 1/8"  | 4 5/16"            |    |    |     |    |   |    |
|                              | 53'            | CMT-15-53-900   | 2'-6 3/4" | 1'-6"    | 4 1/8"             | 1'-6" | 12  | 36"  | 82'            | CMP-15-53-900 | 1'-10 1/8" | 1'-6"                      | 4 1/8"  | 4 5/16"            |    |    |     |    |   |    |
|                              | 63'            | CMT-15-63-900   | 2'-6 3/4" | 1'-6"    | 4 1/8"             | 1'-6" | 14  | 36"  | 93'            | CMP-15-63-900 | 1'-10 1/8" | 1'-6"                      | 4 1/8"  | 4 5/16"            |    |    |     |    |   |    |
|                              | 83'            | CMT-15-83-900   | 2'-6 3/4" | 1'-6"    | 4 1/8"             | 1'-6" | 17  | 54"  | 115'           | CMP-15-83-900 | 1'-10 1/8" | 1'-6"                      | 4 1/8"  | 4 5/16"            |    |    |     |    |   |    |
| 103'                         | CMT-15-103-900 | 2'-6 3/4"       | 1'-6"     | 4 1/8"   | 1'-6"              | 21    | 54" | 137' | CMP-15-103-900 | 1'-10 1/8"    | 1'-6"      | 4 1/8"                     | 4 5/16" |                    |    |    |     |    |   |    |
| 20'                          | 23'            | CMT-20-23-900   | 2'-6 3/4" | 1'-6"    | 4 1/8"             | 1'-6" | 9   | 12"  | 54'            | CMP-20-23-900 | 1'-10 1/8" | 1'-6"                      | 4 1/8"  | 4 5/16"            |    |    |     |    |   |    |
|                              | 33'            | CMT-20-33-900   | 2'-6 3/4" | 1'-6"    | 4 1/8"             | 1'-6" | 11  | 24"  | 65'            | CMP-20-33-900 | 1'-10 1/8" | 1'-6"                      | 4 1/8"  | 4 5/16"            |    |    |     |    |   |    |
|                              | 43'            | CMT-20-43-900   | 2'-6 3/4" | 1'-6"    | 4 1/8"             | 1'-6" | 13  | 24"  | 75'            | CMP-20-43-900 | 1'-10 1/8" | 1'-6"                      | 4 1/8"  | 4 5/16"            |    |    |     |    |   |    |
|                              | 53'            | CMT-20-53-900   | 2'-6 3/4" | 1'-6"    | 4 1/8"             | 1'-6" | 14  | 36"  | 87'            | CMP-20-53-900 | 1'-10 1/8" | 1'-6"                      | 4 1/8"  | 4 5/16"            |    |    |     |    |   |    |
|                              | 63'            | CMT-20-63-900   | 2'-6 3/4" | 1'-6"    | 4 1/8"             | 1'-6" | 16  | 36"  | 98'            | CMP-20-63-900 | 1'-10 1/8" | 1'-6"                      | 4 1/8"  | 4 5/16"            |    |    |     |    |   |    |
|                              | 83'            | CMT-20-83-900   | 2'-6 3/4" | 1'-6"    | 4 1/8"             | 1'-6" | 19  | 54"  | 120'           | CMP-20-83-900 | 1'-10 1/8" | 1'-6"                      | 4 1/8"  | 4 5/16"            |    |    |     |    |   |    |
| 103'                         | CMT-20-103-900 | 2'-6 3/4"       | 1'-6"     | 4 1/8"   | 1'-6"              | 23    | 54" | 142' | CMP-20-103-900 | 1'-10 1/8"    | 1'-6"      | 4 1/8"                     | 4 5/16" |                    |    |    |     |    |   |    |
| 23'                          | 23'            | CMT-23-23-900   | 2'-6 3/4" | 1'-6"    | 4 1/8"             | 1'-6" | 10  | 12"  | 58'            | CMP-23-23-900 | 1'-10 1/8" | 1'-6"                      | 4 1/8"  | 4 5/16"            |    |    |     |    |   |    |
|                              | 33'            | CMT-23-33-900   | 2'-6 3/4" | 1'-6"    | 4 1/8"             | 1'-6" | 12  | 24"  | 69'            | CMP-23-33-900 | 1'-10 1/8" | 1'-6"                      | 4 1/8"  | 4 5/16"            |    |    |     |    |   |    |
|                              | 43'            | CMT-23-43-900   | 2'-6 3/4" | 1'-6"    | 4 1/8"             | 1'-6" | 14  | 24"  | 79'            | CMP-23-43-900 | 1'-10 1/8" | 1'-6"                      | 4 1/8"  | 4 5/16"            |    |    |     |    |   |    |
|                              | 53'            | CMT-23-53-900   | 2'-6 3/4" | 1'-6"    | 4 1/8"             | 1'-6" | 15  | 36"  | 91'            | CMP-23-53-900 | 1'-10 1/8" | 1'-6"                      | 4 1/8"  | 4 5/16"            |    |    |     |    |   |    |
|                              | 63'            | CMT-23-63-900   | 2'-6 3/4" | 1'-6"    | 4 1/8"             | 1'-6" | 17  | 36"  | 102'           | CMP-23-63-900 | 1'-10 1/8" | 1'-6"                      | 4 1/8"  | 4 5/16"            |    |    |     |    |   |    |
|                              | 83'            | CMT-23-83-900   | 2'-6 3/4" | 1'-6"    | 4 1/8"             | 1'-6" | 20  | 54"  | 124'           | CMP-23-83-900 | 1'-10 1/8" | 1'-6"                      | 4 1/8"  | 4 5/16"            |    |    |     |    |   |    |
| 103'                         | CMT-23-103-900 | 2'-6 3/4"       | 1'-6"     | 4 1/8"   | 1'-6"              | 24    | 54" | 146' | CMP-23-103-900 | 1'-10 1/8"    | 1'-6"      | 4 1/8"                     | 4 5/16" |                    |    |    |     |    |   |    |
| 28'                          | 23'            | CMT-28-23-900   | 2'-6 3/4" | 1'-8"    | 4 1/8"             | 1'-6" | 11  | 12"  | 63'            | CMP-28-23-900 | 2'-0 1/8"  | 1'-8"                      | 4 1/8"  | 4 5/16"            |    |    |     |    |   |    |
|                              | 33'            | CMT-28-33-900   | 2'-6 3/4" | 1'-8"    | 4 1/8"             | 1'-6" | 13  | 24"  | 74'            | CMP-28-33-900 | 2'-0 1/8"  | 1'-8"                      | 4 1/8"  | 4 5/16"            |    |    |     |    |   |    |
|                              | 43'            | CMT-28-43-900   | 2'-6 3/4" | 1'-8"    | 4 1/8"             | 1'-6" | 15  | 24"  | 85'            | CMP-28-43-900 | 2'-0 1/8"  | 1'-8"                      | 4 1/8"  | 4 5/16"            |    |    |     |    |   |    |
|                              | 53'            | CMT-28-53-900   | 2'-6 3/4" | 1'-8"    | 4 1/8"             | 1'-6" | 16  | 36"  | 96'            | CMP-28-53-900 | 2'-0 1/8"  | 1'-8"                      | 4 1/8"  | 4 5/16"            |    |    |     |    |   |    |
|                              | 63'            | CMT-28-63-900   | 2'-6 3/4" | 1'-8"    | 4 1/8"             | 1'-6" | 18  | 36"  | 107'           | CMP-28-63-900 | 2'-0 1/8"  | 1'-8"                      | 4 1/8"  | 4 5/16"            |    |    |     |    |   |    |
|                              | 83'            | CMT-28-83-900   | 2'-6 3/4" | 1'-8"    | 4 1/8"             | 1'-6" | 21  | 54"  | 129'           | CMP-28-83-900 | 2'-0 1/8"  | 1'-8"                      | 4 1/8"  | 4 5/16"            |    |    |     |    |   |    |
| 103'                         | CMT-28-103-900 | 2'-6 3/4"       | 1'-8"     | 4 1/8"   | 1'-6"              | 25    | 54" | 151' | CMP-28-103-900 | 2'-0 1/8"     | 1'-8"      | 4 1/8"                     | 4 5/16" |                    |    |    |     |    |   |    |



6' - 0" / 20' - 0" MAXIMUM SUPPORT CENTERS

4,000 LB. CAPACITY

8' - 10' - 15' - 20' - 23' - 28' BRIDGE LENGTH

25' - 0" MAXIMUM SUPPORT CENTERS

| TRUSSED TRACK RUNWAY SYSTEMS |      |                |            |          |                    |     |    |     |              |     |     |     |
|------------------------------|------|----------------|------------|----------|--------------------|-----|----|-----|--------------|-----|-----|-----|
| SYSTEM DATA                  |      | MODEL NUMBER   |            |          | BRIDGE/RUNWAY DATA |     |    |     | FESTOON DATA |     |     |     |
| BL                           | RL   | CMT            | BL         | RL       | TS                 | BRH | BH | C   | RH           | QTY | FTE | FCL |
| 8'                           | 28'  | CMT-8-28-425   | 1'-3 1/2"  | 1 11/16" | 2 1/4"             | 11" | 6  | 24" | 26'          |     |     |     |
|                              | 53'  | CMT-8-53-425   | 1'-3 1/2"  | 1 11/16" | 2 1/4"             | 11" | 10 | 36" | 74'          |     |     |     |
|                              | 78'  | CMT-8-78-425   | 1'-3 1/2"  | 1 11/16" | 2 1/4"             | 11" | 14 | 54" | 101'         |     |     |     |
|                              | 103' | CMT-8-103-425  | 1'-3 1/2"  | 1 11/16" | 2 1/4"             | 11" | 19 | 54" | 129'         |     |     |     |
| 10'                          | 28'  | CMT-10-28-425  | 1'-3 1/2"  | 3 11/16" | 2 1/4"             | 11" | 7  | 24" | 48'          |     |     |     |
|                              | 53'  | CMT-10-53-425  | 1'-3 1/2"  | 3 11/16" | 2 1/4"             | 11" | 11 | 36" | 76'          |     |     |     |
|                              | 78'  | CMT-10-78-425  | 1'-3 1/2"  | 3 11/16" | 2 1/4"             | 11" | 15 | 54" | 103'         |     |     |     |
|                              | 103' | CMT-10-103-425 | 1'-3 1/2"  | 3 11/16" | 2 1/4"             | 11" | 20 | 54" | 131'         |     |     |     |
| 15'                          | 28'  | CMT-15-28-425  | 1'-3 1/2"  | 9"       | 2 1/4"             | 11" | 8  | 24" | 54'          |     |     |     |
|                              | 53'  | CMT-15-53-425  | 1'-3 1/2"  | 9"       | 2 1/4"             | 11" | 12 | 36" | 82'          |     |     |     |
|                              | 78'  | CMT-15-78-425  | 1'-3 1/2"  | 9"       | 2 1/4"             | 11" | 16 | 54" | 109'         |     |     |     |
|                              | 103' | CMT-15-103-425 | 1'-3 1/2"  | 9"       | 2 1/4"             | 11" | 21 | 54" | 137'         |     |     |     |
| 20'                          | 28'  | CMT-20-28-425  | 1'-3 1/2"  | 9"       | 2 1/4"             | 11" | 10 | 24" | 59'          |     |     |     |
|                              | 53'  | CMT-20-53-425  | 1'-3 1/2"  | 9"       | 2 1/4"             | 11" | 14 | 36" | 87'          |     |     |     |
|                              | 78'  | CMT-20-78-425  | 1'-3 1/2"  | 9"       | 2 1/4"             | 11" | 18 | 54" | 114'         |     |     |     |
|                              | 103' | CMT-20-103-425 | 1'-3 1/2"  | 9"       | 2 1/4"             | 11" | 23 | 54" | 142'         |     |     |     |
| 23'                          | 28'  | CMT-23-28-425  | 1'-3 1/2"  | 9"       | 2 1/4"             | 11" | 11 | 24" | 63'          |     |     |     |
|                              | 53'  | CMT-23-53-425  | 1'-3 1/2"  | 9"       | 2 1/4"             | 11" | 15 | 36" | 91'          |     |     |     |
|                              | 78'  | CMT-23-78-425  | 1'-3 1/2"  | 9"       | 2 1/4"             | 11" | 19 | 54" | 118'         |     |     |     |
|                              | 103' | CMT-23-103-425 | 1'-3 1/2"  | 9"       | 2 1/4"             | 11" | 24 | 54" | 146'         |     |     |     |
| 28'                          | 28'  | CMT-28-28-425  | 1'-5 7/16" | 11"      | 2 1/4"             | 11" | 12 | 24" | 68'          |     |     |     |
|                              | 53'  | CMT-28-53-425  | 1'-5 7/16" | 11"      | 2 1/4"             | 11" | 16 | 36" | 96'          |     |     |     |
|                              | 78'  | CMT-28-78-425  | 1'-5 7/16" | 11"      | 2 1/4"             | 11" | 20 | 54" | 123'         |     |     |     |
|                              | 103' | CMT-28-103-425 | 1'-5 7/16" | 11"      | 2 1/4"             | 11" | 25 | 54" | 151'         |     |     |     |

25' - 0" MAXIMUM SUPPORT CENTERS  
250 LB. CAPACITY

| TRUSSED TRACK RUNWAY SYSTEMS |      |                |            |           |                    |          |    |     |              |     |     |     |
|------------------------------|------|----------------|------------|-----------|--------------------|----------|----|-----|--------------|-----|-----|-----|
| SYSTEM DATA                  |      | MODEL NUMBER   |            |           | BRIDGE/RUNWAY DATA |          |    |     | FESTOON DATA |     |     |     |
| BL                           | RL   | CMT            | BL         | RL        | TS                 | BRH      | BH | C   | RH           | QTY | FTE | FCL |
| 8'                           | 28'  | CMT-8-28-525   | 1'-6 7/16" | 2 3/8"    | 2 5/8"             | 1-0 3/8" | 6  | 24" | 26'          |     |     |     |
|                              | 53'  | CMT-8-53-525   | 1'-6 7/16" | 2 3/8"    | 2 5/8"             | 1-0 3/8" | 10 | 36" | 74'          |     |     |     |
|                              | 78'  | CMT-8-78-525   | 1'-6 7/16" | 2 3/8"    | 2 5/8"             | 1-0 3/8" | 14 | 54" | 101'         |     |     |     |
|                              | 103' | CMT-8-103-525  | 1'-6 7/16" | 2 3/8"    | 2 5/8"             | 1-0 3/8" | 19 | 54" | 129'         |     |     |     |
| 10'                          | 28'  | CMT-10-28-525  | 1'-6 7/16" | 6 3/8"    | 2 5/8"             | 1-0 3/8" | 7  | 24" | 48'          |     |     |     |
|                              | 53'  | CMT-10-53-525  | 1'-6 7/16" | 6 3/8"    | 2 5/8"             | 1-0 3/8" | 11 | 36" | 76'          |     |     |     |
|                              | 78'  | CMT-10-78-525  | 1'-6 7/16" | 6 3/8"    | 2 5/8"             | 1-0 3/8" | 15 | 54" | 103'         |     |     |     |
|                              | 103' | CMT-10-103-525 | 1'-6 7/16" | 6 3/8"    | 2 5/8"             | 1-0 3/8" | 20 | 54" | 131'         |     |     |     |
| 15'                          | 28'  | CMT-15-28-525  | 1'-6 7/16" | 10"       | 2 5/8"             | 1-0 3/8" | 8  | 24" | 54'          |     |     |     |
|                              | 53'  | CMT-15-53-525  | 1'-6 7/16" | 10"       | 2 5/8"             | 1-0 3/8" | 12 | 36" | 82'          |     |     |     |
|                              | 78'  | CMT-15-78-525  | 1'-6 7/16" | 10"       | 2 5/8"             | 1-0 3/8" | 16 | 54" | 109'         |     |     |     |
|                              | 103' | CMT-15-103-525 | 1'-6 7/16" | 10"       | 2 5/8"             | 1-0 3/8" | 21 | 54" | 137'         |     |     |     |
| 20'                          | 28'  | CMT-20-28-525  | 1'-6 7/16" | 10"       | 2 5/8"             | 1-0 3/8" | 10 | 24" | 59'          |     |     |     |
|                              | 53'  | CMT-20-53-525  | 1'-6 7/16" | 10"       | 2 5/8"             | 1-0 3/8" | 14 | 36" | 87'          |     |     |     |
|                              | 78'  | CMT-20-78-525  | 1'-6 7/16" | 10"       | 2 5/8"             | 1-0 3/8" | 18 | 54" | 114'         |     |     |     |
|                              | 103' | CMT-20-103-525 | 1'-6 7/16" | 10"       | 2 5/8"             | 1-0 3/8" | 23 | 54" | 142'         |     |     |     |
| 23'                          | 28'  | CMT-23-28-525  | 1'-6 7/16" | 10"       | 2 5/8"             | 1-0 3/8" | 11 | 24" | 63'          |     |     |     |
|                              | 53'  | CMT-23-53-525  | 1'-6 7/16" | 10"       | 2 5/8"             | 1-0 3/8" | 15 | 36" | 91'          |     |     |     |
|                              | 78'  | CMT-23-78-525  | 1'-6 7/16" | 10"       | 2 5/8"             | 1-0 3/8" | 19 | 54" | 118'         |     |     |     |
|                              | 103' | CMT-23-103-525 | 1'-6 9/16" | 10"       | 2 5/8"             | 1-0 3/8" | 24 | 54" | 146'         |     |     |     |
| 28'                          | 28'  | CMT-28-28-525  | 1'-8 1/4"  | 1'-0 3/8" | 2 5/8"             | 1-0 3/8" | 12 | 24" | 68'          |     |     |     |
|                              | 53'  | CMT-28-53-525  | 1'-8 1/4"  | 1'-0 3/8" | 2 5/8"             | 1-0 3/8" | 16 | 36" | 96'          |     |     |     |
|                              | 78'  | CMT-28-78-525  | 1'-8 1/4"  | 1'-0 3/8" | 2 5/8"             | 1-0 3/8" | 20 | 54" | 123'         |     |     |     |
|                              | 103' | CMT-28-103-525 | 1'-8 1/4"  | 1'-0 3/8" | 2 5/8"             | 1-0 3/8" | 25 | 54" | 151'         |     |     |     |
| 34'                          | 28'  | CMT-34-28-525  | 1'-8 1/4"  | 1'-2 3/8" | 2 5/8"             | 1-0 3/8" | 15 | 24" | 75'          |     |     |     |
|                              | 53'  | CMT-34-53-525  | 1'-8 1/4"  | 1'-2 3/8" | 2 5/8"             | 1-0 3/8" | 19 | 36" | 103'         |     |     |     |
|                              | 78'  | CMT-34-78-525  | 1'-8 1/4"  | 1'-2 3/8" | 2 5/8"             | 1-0 3/8" | 23 | 54" | 130'         |     |     |     |
|                              | 103' | CMT-34-103-525 | 1'-8 1/4"  | 1'-2 3/8" | 2 5/8"             | 1-0 3/8" | 28 | 54" | 158'         |     |     |     |

25' - 0" MAXIMUM SUPPORT CENTERS  
500 LB. CAPACITY

Hoist not included.

8' - 10' - 15' - 20' - 23' - 28' - 34' BRIDGE LENGTH

| TRUSSED TRACK RUNWAY SYSTEMS |      |                |           |           |                    |          |    |     |              |     |     |
|------------------------------|------|----------------|-----------|-----------|--------------------|----------|----|-----|--------------|-----|-----|
| SYSTEM DATA                  |      | MODEL NUMBER   |           |           | BRIDGE/RUNWAY DATA |          |    |     | FESTOON DATA |     |     |
| BL                           | RL   | CMT            | BL        | RL        | TS                 | BRH      | BH | C   | RH           | FTE | FCL |
| 8'                           | 28'  | CMT-8-28-625   | 1'-9 1/8" | 2 15/16"  | 3 1/16"            | 1-1 7/8" | 6  | 24" | 46'          |     |     |
|                              | 53'  | CMT-8-53-625   | 1'-9 1/8" | 2 15/16"  | 3 1/16"            | 1-1 7/8" | 10 | 36" | 74'          |     |     |
|                              | 78'  | CMT-8-78-625   | 1'-9 1/8" | 2 15/16"  | 3 1/16"            | 1-1 7/8" | 14 | 54" | 101'         |     |     |
|                              | 103' | CMT-8-103-625  | 1'-9 1/8" | 2 15/16"  | 3 1/16"            | 1-1 7/8" | 19 | 54" | 129'         |     |     |
| 10'                          | 28'  | CMT-10-28-625  | 1'-9 1/8" | 5 15/16"  | 3 1/16"            | 1-1 7/8" | 7  | 24" | 48'          |     |     |
|                              | 53'  | CMT-10-53-625  | 1'-9 1/8" | 5 15/16"  | 3 1/16"            | 1-1 7/8" | 11 | 36" | 76'          |     |     |
|                              | 78'  | CMT-10-78-625  | 1'-9 1/8" | 5 15/16"  | 3 1/16"            | 1-1 7/8" | 15 | 54" | 103'         |     |     |
|                              | 103' | CMT-10-103-625 | 1'-9 1/8" | 5 15/16"  | 3 1/16"            | 1-1 7/8" | 20 | 54" | 131'         |     |     |
| 15'                          | 28'  | CMT-15-28-625  | 1'-9 1/8" | 11"       | 3 1/16"            | 1-1 7/8" | 8  | 24" | 54'          |     |     |
|                              | 53'  | CMT-15-53-625  | 1'-9 1/8" | 11"       | 3 1/16"            | 1-1 7/8" | 12 | 36" | 82'          |     |     |
|                              | 78'  | CMT-15-78-625  | 1'-9 1/8" | 11"       | 3 1/16"            | 1-1 7/8" | 16 | 54" | 109'         |     |     |
|                              | 103' | CMT-15-103-625 | 1'-9 1/8" | 11"       | 3 1/16"            | 1-1 7/8" | 21 | 54" | 137'         |     |     |
| 20'                          | 28'  | CMT-20-28-625  | 1'-9 1/8" | 11"       | 3 1/16"            | 1-1 7/8" | 10 | 24" | 59'          |     |     |
|                              | 53'  | CMT-20-53-625  | 1'-9 1/8" | 11"       | 3 1/16"            | 1-1 7/8" | 14 | 36" | 87'          |     |     |
|                              | 78'  | CMT-20-78-625  | 1'-9 1/8" | 11"       | 3 1/16"            | 1-1 7/8" | 18 | 54" | 114'         |     |     |
|                              | 103' | CMT-20-103-625 | 1'-9 1/8" | 11"       | 3 1/16"            | 1-1 7/8" | 23 | 54" | 142'         |     |     |
| 23'                          | 28'  | CMT-23-28-625  | 1'-9 1/8" | 11"       | 3 1/16"            | 1-1 7/8" | 11 | 24" | 63'          |     |     |
|                              | 53'  | CMT-23-53-625  | 1'-9 1/8" | 11"       | 3 1/16"            | 1-1 7/8" | 15 | 36" | 91'          |     |     |
|                              | 78'  | CMT-23-78-625  | 1'-9 1/8" | 11"       | 3 1/16"            | 1-1 7/8" | 19 | 54" | 118'         |     |     |
|                              | 103' | CMT-23-103-625 | 1'-9 1/8" | 11"       | 3 1/16"            | 1-1 7/8" | 24 | 54" | 146'         |     |     |
| 28'                          | 28'  | CMT-28-28-625  | 1'-11"    | 1'-1 7/8" | 3 1/16"            | 1-1 7/8" | 12 | 24" | 68'          |     |     |
|                              | 53'  | CMT-28-53-625  | 1'-11"    | 1'-1 7/8" | 3 1/16"            | 1-1 7/8" | 16 | 36" | 96'          |     |     |
|                              | 78'  | CMT-28-78-625  | 1'-11"    | 1'-1 7/8" | 3 1/16"            | 1-1 7/8" | 20 | 54" | 123'         |     |     |
|                              | 103' | CMT-28-103-625 | 1'-11"    | 1'-1 7/8" | 3 1/16"            | 1-1 7/8" | 25 | 54" | 151'         |     |     |
| 34'                          | 28'  | CMT-34-28-625  | 1'-11"    | 1'-5"     | 3 1/16"            | 1-1 7/8" | 15 | 24" | 75'          |     |     |
|                              | 53'  | CMT-34-53-625  | 1'-11"    | 1'-5"     | 3 1/16"            | 1-1 7/8" | 19 | 36" | 103'         |     |     |
|                              | 78'  | CMT-34-78-625  | 1'-11"    | 1'-5"     | 3 1/16"            | 1-1 7/8" | 23 | 54" | 130'         |     |     |
|                              | 103' | CMT-34-103-625 | 1'-11"    | 1'-5"     | 3 1/16"            | 1-1 7/8" | 28 | 54" | 158'         |     |     |

25'- 0" MAXIMUM SUPPORT CENTERS  
1,000 LB. CAPACITY

| TRUSSED TRACK RUNWAY SYSTEMS |      |                |           |          |                    |      |    |     |              |     |     |
|------------------------------|------|----------------|-----------|----------|--------------------|------|----|-----|--------------|-----|-----|
| SYSTEM DATA                  |      | MODEL NUMBER   |           |          | BRIDGE/RUNWAY DATA |      |    |     | FESTOON DATA |     |     |
| BL                           | RL   | CMT            | BL        | RL       | TS                 | BRH  | BH | C   | RH           | FTE | FCL |
| 8'                           | 28'  | CMT-8-28-725   | 2'-1 3/4" | 4 5/16"  | 4 1/8"             | 1-4" | 6  | 24" | 46'          |     |     |
|                              | 53'  | CMT-8-53-725   | 2'-1 3/4" | 4 5/16"  | 4 1/8"             | 1-4" | 10 | 36" | 74'          |     |     |
|                              | 78'  | CMT-8-78-725   | 2'-1 3/4" | 4 5/16"  | 4 1/8"             | 1-4" | 14 | 54" | 101'         |     |     |
|                              | 103' | CMT-8-103-725  | 2'-1 3/4" | 2 15/16" | 4 1/8"             | 1-4" | 19 | 54" | 129'         |     |     |
| 10'                          | 28'  | CMT-10-28-725  | 2'-1 3/4" | 4 5/16"  | 4 1/8"             | 1-4" | 7  | 24" | 48'          |     |     |
|                              | 53'  | CMT-10-53-725  | 2'-1 3/4" | 4 5/16"  | 4 1/8"             | 1-4" | 11 | 36" | 76'          |     |     |
|                              | 78'  | CMT-10-78-725  | 2'-1 3/4" | 4 5/16"  | 4 1/8"             | 1-4" | 15 | 54" | 103'         |     |     |
|                              | 103' | CMT-10-103-725 | 2'-1 3/4" | 4 5/16"  | 4 1/8"             | 1-4" | 20 | 54" | 131'         |     |     |
| 15'                          | 28'  | CMT-15-28-725  | 2'-1 3/4" | 1'-0"    | 4 1/8"             | 1-4" | 8  | 24" | 54'          |     |     |
|                              | 53'  | CMT-15-53-725  | 2'-1 3/4" | 1'-0"    | 4 1/8"             | 1-4" | 12 | 36" | 82'          |     |     |
|                              | 78'  | CMT-15-78-725  | 2'-1 3/4" | 1'-0"    | 4 1/8"             | 1-4" | 16 | 54" | 109'         |     |     |
|                              | 103' | CMT-15-103-725 | 2'-1 3/4" | 1'-0"    | 4 1/8"             | 1-4" | 21 | 54" | 137'         |     |     |
| 20'                          | 28'  | CMT-20-28-725  | 2'-1 3/4" | 1'-0"    | 4 1/8"             | 1-4" | 10 | 24" | 59'          |     |     |
|                              | 53'  | CMT-20-53-725  | 2'-1 3/4" | 1'-0"    | 4 1/8"             | 1-4" | 14 | 36" | 87'          |     |     |
|                              | 78'  | CMT-20-78-725  | 2'-1 3/4" | 1'-0"    | 4 1/8"             | 1-4" | 18 | 54" | 114'         |     |     |
|                              | 103' | CMT-20-103-725 | 2'-1 3/4" | 1'-0"    | 4 1/8"             | 1-4" | 23 | 54" | 142'         |     |     |
| 23'                          | 28'  | CMT-23-28-725  | 2'-1 3/4" | 1'-0"    | 4 1/8"             | 1-4" | 11 | 24" | 63'          |     |     |
|                              | 53'  | CMT-23-53-725  | 2'-1 3/4" | 1'-0"    | 4 1/8"             | 1-4" | 15 | 36" | 91'          |     |     |
|                              | 78'  | CMT-23-78-725  | 2'-1 3/4" | 1'-0"    | 4 1/8"             | 1-4" | 19 | 54" | 118'         |     |     |
|                              | 103' | CMT-23-103-725 | 2'-1 3/4" | 1'-0"    | 4 1/8"             | 1-4" | 24 | 54" | 146'         |     |     |
| 28'                          | 28'  | CMT-28-28-725  | 2'-3 5/8" | 1'-4"    | 4 1/8"             | 1-4" | 12 | 24" | 68'          |     |     |
|                              | 53'  | CMT-28-53-725  | 2'-3 5/8" | 1'-4"    | 4 1/8"             | 1-4" | 16 | 36" | 96'          |     |     |
|                              | 78'  | CMT-28-78-725  | 2'-3 5/8" | 1'-4"    | 4 1/8"             | 1-4" | 20 | 54" | 123'         |     |     |
|                              | 103' | CMT-28-103-725 | 2'-3 5/8" | 1'-4"    | 4 1/8"             | 1-4" | 25 | 54" | 151'         |     |     |
| 34'                          | 28'  | CMT-34-28-725  | 2'-3 5/8" | 1'-6"    | 4 1/8"             | 1-4" | 15 | 24" | 75'          |     |     |
|                              | 53'  | CMT-34-53-725  | 2'-3 5/8" | 1'-6"    | 4 1/8"             | 1-4" | 19 | 36" | 103'         |     |     |
|                              | 78'  | CMT-34-78-725  | 2'-3 5/8" | 1'-6"    | 4 1/8"             | 1-4" | 23 | 54" | 130'         |     |     |
|                              | 103' | CMT-34-103-725 | 2'-3 5/8" | 1'-6"    | 4 1/8"             | 1-4" | 28 | 54" | 158'         |     |     |

25'- 0" MAXIMUM SUPPORT CENTERS  
2,000 LB. CAPACITY

25' - 0" MAXIMUM SUPPORT CENTERS

8' - 10' - 15' - 20' - 23' - 28' - 34' BRIDGE LENGTH

25' - 0" / 30' - 0" MAXIMUM SUPPORT CENTERS

| TRUSSED TRACK RUNWAY SYSTEMS |      |                |           |          |                    |       |    |     |              |     |     |     |
|------------------------------|------|----------------|-----------|----------|--------------------|-------|----|-----|--------------|-----|-----|-----|
| SYSTEM DATA                  |      | MODEL NUMBER   |           |          | BRIDGE/RUNWAY DATA |       |    |     | FESTOON DATA |     |     |     |
| BL                           | RL   | CMT            | BL        | RL       | TS                 | BRH   | BH | C   | RH           | QTY | FTE | FCL |
| 8'                           | 28'  | CMT-8-28-925   | 2'-8 3/4" | 4 5/16"  | 4 1/8"             | 1'-8" | 6  | 24" | 46'          |     |     |     |
|                              | 53'  | CMT-8-53-925   | 2'-8 3/4" | 4 5/16"  | 4 1/8"             | 1'-8" | 10 | 36" | 74'          |     |     |     |
|                              | 78'  | CMT-8-78-925   | 2'-8 3/4" | 4 5/16"  | 4 1/8"             | 1'-8" | 14 | 54" | 101'         |     |     |     |
|                              | 103' | CMT-8-103-925  | 2'-8 3/4" | 4 5/16"  | 4 1/8"             | 1'-8" | 19 | 54" | 129'         |     |     |     |
| 10'                          | 28'  | CMT-10-28-925  | 2'-8 3/4" | 7 13/16" | 4 1/8"             | 1'-8" | 7  | 24" | 48'          |     |     |     |
|                              | 53'  | CMT-10-53-925  | 2'-8 3/4" | 7 13/16" | 4 1/8"             | 1'-8" | 11 | 36" | 76'          |     |     |     |
|                              | 78'  | CMT-10-78-925  | 2'-8 3/4" | 7 13/16" | 4 1/8"             | 1'-8" | 15 | 54" | 103'         |     |     |     |
|                              | 103' | CMT-10-103-925 | 2'-8 3/4" | 7 13/16" | 4 1/8"             | 1'-8" | 20 | 54" | 131'         |     |     |     |
| 15'                          | 28'  | CMT-15-28-925  | 2'-8 3/4" | 1'-6"    | 4 1/8"             | 1'-8" | 8  | 24" | 54'          |     |     |     |
|                              | 53'  | CMT-15-53-925  | 2'-8 3/4" | 1'-6"    | 4 1/8"             | 1'-8" | 12 | 36" | 82'          |     |     |     |
|                              | 78'  | CMT-15-78-925  | 2'-8 3/4" | 1'-6"    | 4 1/8"             | 1'-8" | 16 | 54" | 109'         |     |     |     |
|                              | 103' | CMT-15-103-925 | 2'-8 3/4" | 1'-6"    | 4 1/8"             | 1'-8" | 21 | 54" | 137'         |     |     |     |
| 20'                          | 28'  | CMT-20-28-925  | 2'-8 3/4" | 1'-6"    | 4 1/8"             | 1'-8" | 10 | 24" | 59'          |     |     |     |
|                              | 53'  | CMT-20-53-925  | 2'-8 3/4" | 1'-6"    | 4 1/8"             | 1'-8" | 14 | 36" | 87'          |     |     |     |
|                              | 78'  | CMT-20-78-925  | 2'-8 3/4" | 1'-6"    | 4 1/8"             | 1'-8" | 18 | 54" | 114'         |     |     |     |
|                              | 103' | CMT-20-103-925 | 2'-8 3/4" | 1'-6"    | 4 1/8"             | 1'-8" | 23 | 54" | 142'         |     |     |     |
| 23'                          | 28'  | CMT-23-28-925  | 2'-8 3/4" | 1'-6"    | 4 1/8"             | 1'-8" | 11 | 24" | 63'          |     |     |     |
|                              | 53'  | CMT-23-53-925  | 2'-8 3/4" | 1'-6"    | 4 1/8"             | 1'-8" | 15 | 36" | 91'          |     |     |     |
|                              | 78'  | CMT-23-78-925  | 2'-8 3/4" | 1'-6"    | 4 1/8"             | 1'-8" | 19 | 54" | 118'         |     |     |     |
|                              | 103' | CMT-23-103-925 | 2'-8 3/4" | 1'-6"    | 4 1/8"             | 1'-8" | 24 | 54" | 146'         |     |     |     |
| 28'                          | 28'  | CMT-28-28-925  | 2'-8 3/4" | 1'-8"    | 4 1/8"             | 1'-8" | 12 | 24" | 68'          |     |     |     |
|                              | 53'  | CMT-28-53-925  | 2'-8 3/4" | 1'-8"    | 4 1/8"             | 1'-8" | 16 | 36" | 96'          |     |     |     |
|                              | 78'  | CMT-28-78-925  | 2'-8 3/4" | 1'-8"    | 4 1/8"             | 1'-8" | 20 | 54" | 123'         |     |     |     |
|                              | 103' | CMT-28-103-925 | 2'-8 3/4" | 1'-8"    | 4 1/8"             | 1'-8" | 25 | 54" | 151'         |     |     |     |

25'- 0" MAXIMUM SUPPORT CENTERS  
4,000 LB. CAPACITY

8' - 10' - 15' - 20' - 23' - 28' - 34' BRIDGE LENGTH

| TRUSSED TRACK RUNWAY SYSTEMS |      |                |            |           |                    |           |    |     |              |     |     |     |
|------------------------------|------|----------------|------------|-----------|--------------------|-----------|----|-----|--------------|-----|-----|-----|
| SYSTEM DATA                  |      | MODEL NUMBER   |            |           | BRIDGE/RUNWAY DATA |           |    |     | FESTOON DATA |     |     |     |
| BL                           | RL   | CMT            | BL         | RL        | TS                 | BRH       | BH | C   | RH           | QTY | FTE | FCL |
| 8'                           | 34'  | CMT-8-34-530   | 1'-8 9/16" | 2 3/8"    | 2 5/8"             | 1'-2 3/8" | 7  | 24" | 53'          |     |     |     |
|                              | 64'  | CMT-8-64-530   | 1'-8 9/16" | 2 3/8"    | 2 5/8"             | 1'-2 3/8" | 12 | 36" | 86'          |     |     |     |
|                              | 94'  | CMT-8-94-530   | 1'-8 9/16" | 2 3/8"    | 2 5/8"             | 1'-2 3/8" | 17 | 54" | 119'         |     |     |     |
|                              | 124' | CMT-8-124-530  | 1'-8 9/16" | 2 3/8"    | 2 5/8"             | 1'-2 3/8" | 22 | 70" | 152'         |     |     |     |
| 10'                          | 34'  | CMT-10-34-530  | 1'-8 9/16" | 6 3/8"    | 2 5/8"             | 1'-2 3/8" | 8  | 24" | 54'          |     |     |     |
|                              | 64'  | CMT-10-64-530  | 1'-8 9/16" | 6 3/8"    | 2 5/8"             | 1'-2 3/8" | 13 | 36" | 88'          |     |     |     |
|                              | 94'  | CMT-10-94-530  | 1'-8 9/16" | 6 3/8"    | 2 5/8"             | 1'-2 3/8" | 18 | 54" | 121'         |     |     |     |
|                              | 124' | CMT-10-124-530 | 1'-8 9/16" | 6 3/8"    | 2 5/8"             | 1'-2 3/8" | 23 | 70" | 154'         |     |     |     |
| 15'                          | 34'  | CMT-15-34-530  | 1'-8 9/16" | 10"       | 2 5/8"             | 1'-2 3/8" | 9  | 24" | 60'          |     |     |     |
|                              | 64'  | CMT-15-64-530  | 1'-8 9/16" | 10"       | 2 5/8"             | 1'-2 3/8" | 14 | 36" | 93'          |     |     |     |
|                              | 94'  | CMT-15-94-530  | 1'-8 9/16" | 10"       | 2 5/8"             | 1'-2 3/8" | 19 | 54" | 126'         |     |     |     |
|                              | 124' | CMT-15-124-530 | 1'-8 9/16" | 10"       | 2 5/8"             | 1'-2 3/8" | 24 | 70" | 159'         |     |     |     |
| 20'                          | 34'  | CMT-20-34-530  | 1'-8 9/16" | 10"       | 2 5/8"             | 1'-2 3/8" | 11 | 24" | 66'          |     |     |     |
|                              | 64'  | CMT-20-64-530  | 1'-8 9/16" | 10"       | 2 5/8"             | 1'-2 3/8" | 16 | 36" | 99'          |     |     |     |
|                              | 94'  | CMT-20-94-530  | 1'-8 9/16" | 10"       | 2 5/8"             | 1'-2 3/8" | 21 | 54" | 132'         |     |     |     |
|                              | 124' | CMT-20-124-530 | 1'-8 9/16" | 10"       | 2 5/8"             | 1'-2 3/8" | 26 | 70" | 165'         |     |     |     |
| 23'                          | 34'  | CMT-23-34-530  | 1'-8 9/16" | 10"       | 2 5/8"             | 1'-2 3/8" | 12 | 24" | 69'          |     |     |     |
|                              | 64'  | CMT-23-64-530  | 1'-8 9/16" | 10"       | 2 5/8"             | 1'-2 3/8" | 17 | 36" | 102'         |     |     |     |
|                              | 94'  | CMT-23-94-530  | 1'-8 9/16" | 10"       | 2 5/8"             | 1'-2 3/8" | 22 | 54" | 135'         |     |     |     |
|                              | 124' | CMT-23-124-530 | 1'-8 9/16" | 10"       | 2 5/8"             | 1'-2 3/8" | 27 | 70" | 168'         |     |     |     |
| 28'                          | 34'  | CMT-28-34-530  | 1'-10 3/8" | 1'-0 3/8" | 2 5/8"             | 1'-2 3/8" | 13 | 24" | 75'          |     |     |     |
|                              | 64'  | CMT-28-64-530  | 1'-10 3/8" | 1'-0 3/8" | 2 5/8"             | 1'-2 3/8" | 18 | 36" | 108'         |     |     |     |
|                              | 94'  | CMT-28-94-530  | 1'-10 3/8" | 1'-0 3/8" | 2 5/8"             | 1'-2 3/8" | 23 | 54" | 141'         |     |     |     |
|                              | 124' | CMT-28-124-530 | 1'-10 3/8" | 1'-0 3/8" | 2 5/8"             | 1'-2 3/8" | 28 | 70" | 174'         |     |     |     |
| 34'                          | 34'  | CMT-34-34-530  | 1'-10 3/8" | 1'-2 3/8" | 2 5/8"             | 1'-2 3/8" | 16 | 24" | 81'          |     |     |     |
|                              | 64'  | CMT-34-64-530  | 1'-10 3/8" | 1'-2 3/8" | 2 5/8"             | 1'-2 3/8" | 21 | 36" | 114'         |     |     |     |
|                              | 94'  | CMT-34-94-530  | 1'-10 3/8" | 1'-2 3/8" | 2 5/8"             | 1'-2 3/8" | 26 | 54" | 147'         |     |     |     |
|                              | 124' | CMT-34-124-530 | 1'-10 3/8" | 1'-2 3/8" | 2 5/8"             | 1'-2 3/8" | 31 | 70" | 180'         |     |     |     |

30'- 0" MAXIMUM SUPPORT CENTERS  
500 LB. CAPACITY



| TRUSSED TRACK RUNWAY SYSTEMS |      |                |           |           |                    |       |    |     |              |     |     |     |
|------------------------------|------|----------------|-----------|-----------|--------------------|-------|----|-----|--------------|-----|-----|-----|
| SYSTEM DATA                  |      | MODEL NUMBER   |           |           | BRIDGE/RUNWAY DATA |       |    |     | FESTOON DATA |     |     |     |
| BL                           | RL   | CMT            | BL        | RL        | TS                 | BRH   | BH | C   | RH           | QTY | FTE | FCL |
| 8'                           | 34'  | CMT-8-34-630   | 2'-0 1/4" | 2 15/16"  | 3 1/16"            | 1'-5" | 7  | 24" | 53'          |     |     |     |
|                              | 64'  | CMT-8-64-630   | 2'-0 1/4" | 2 15/16"  | 3 1/16"            | 1'-5" | 12 | 36" | 86'          |     |     |     |
|                              | 94'  | CMT-8-94-630   | 2'-0 1/4" | 2 15/16"  | 3 1/16"            | 1'-5" | 17 | 54" | 119'         |     |     |     |
|                              | 124' | CMT-8-124-630  | 2'-0 1/4" | 2 15/16"  | 3 1/16"            | 1'-5" | 22 | 70" | 152'         |     |     |     |
| 10'                          | 34'  | CMT-10-34-630  | 2'-0 1/4" | 5 15/16"  | 3 1/16"            | 1'-5" | 8  | 24" | 55'          |     |     |     |
|                              | 64'  | CMT-10-64-630  | 2'-0 1/4" | 5 15/16"  | 3 1/16"            | 1'-5" | 13 | 36" | 88'          |     |     |     |
|                              | 94'  | CMT-10-94-630  | 2'-0 1/4" | 5 15/16"  | 3 1/16"            | 1'-5" | 18 | 54" | 121'         |     |     |     |
|                              | 124' | CMT-10-124-630 | 2'-0 1/4" | 5 15/16"  | 3 1/16"            | 1'-5" | 23 | 70" | 154'         |     |     |     |
| 15'                          | 34'  | CMT-15-34-630  | 2'-0 1/4" | 11"       | 3 1/16"            | 1'-5" | 9  | 24" | 60'          |     |     |     |
|                              | 64'  | CMT-15-64-630  | 2'-0 1/4" | 11"       | 3 1/16"            | 1'-5" | 14 | 36" | 93'          |     |     |     |
|                              | 94'  | CMT-15-94-630  | 2'-0 1/4" | 11"       | 3 1/16"            | 1'-5" | 19 | 54" | 126'         |     |     |     |
|                              | 124' | CMT-15-124-630 | 2'-0 1/4" | 11"       | 3 1/16"            | 1'-5" | 24 | 70" | 159'         |     |     |     |
| 20'                          | 34'  | CMT-20-34-630  | 2'-0 1/4" | 11"       | 3 1/16"            | 1'-5" | 11 | 24" | 66'          |     |     |     |
|                              | 64'  | CMT-20-64-630  | 2'-0 1/4" | 11"       | 3 1/16"            | 1'-5" | 16 | 36" | 99'          |     |     |     |
|                              | 94'  | CMT-20-94-630  | 2'-0 1/4" | 11"       | 3 1/16"            | 1'-5" | 21 | 54" | 132'         |     |     |     |
|                              | 124' | CMT-20-124-630 | 2'-0 1/4" | 11"       | 3 1/16"            | 1'-5" | 26 | 70" | 165'         |     |     |     |
| 23'                          | 34'  | CMT-23-34-630  | 2'-0 1/4" | 11"       | 3 1/16"            | 1'-5" | 12 | 24" | 69'          |     |     |     |
|                              | 64'  | CMT-23-64-630  | 2'-0 1/4" | 11"       | 3 1/16"            | 1'-5" | 17 | 36" | 102'         |     |     |     |
|                              | 94'  | CMT-23-94-630  | 2'-0 1/4" | 11"       | 3 1/16"            | 1'-5" | 22 | 54" | 135'         |     |     |     |
|                              | 124' | CMT-23-124-630 | 2'-0 1/4" | 11"       | 3 1/16"            | 1'-5" | 27 | 70" | 168'         |     |     |     |
| 28'                          | 34'  | CMT-28-34-630  | 2'-2 1/8" | 1'-1 7/8" | 3 1/16"            | 1'-5" | 13 | 24" | 75'          |     |     |     |
|                              | 64'  | CMT-28-64-630  | 2'-2 1/8" | 1'-1 7/8" | 3 1/16"            | 1'-5" | 18 | 36" | 108'         |     |     |     |
|                              | 94'  | CMT-28-94-630  | 2'-2 1/8" | 1'-1 7/8" | 3 1/16"            | 1'-5" | 23 | 54" | 141'         |     |     |     |
|                              | 124' | CMT-28-124-630 | 2'-2 1/8" | 1'-1 7/8" | 3 1/16"            | 1'-5" | 28 | 70" | 174'         |     |     |     |
| 34'                          | 34'  | CMT-34-34-630  | 2'-2 1/8" | 1'-5"     | 3 1/16"            | 1'-5" | 16 | 24" | 81'          |     |     |     |
|                              | 64'  | CMT-34-64-630  | 2'-2 1/8" | 1'-5"     | 3 1/16"            | 1'-5" | 21 | 36" | 114'         |     |     |     |
|                              | 94'  | CMT-34-94-630  | 2'-2 1/8" | 1'-5"     | 3 1/16"            | 1'-5" | 26 | 54" | 147'         |     |     |     |
|                              | 124' | CMT-34-124-630 | 2'-2 1/8" | 1'-5"     | 3 1/16"            | 1'-5" | 31 | 70" | 180'         |     |     |     |

**30'- 0" MAXIMUM SUPPORT CENTERS**  
**1,000 LB. CAPACITY**

| TRUSSED TRACK RUNWAY SYSTEMS |      |                |           |         |                    |       |    |     |              |     |     |     |
|------------------------------|------|----------------|-----------|---------|--------------------|-------|----|-----|--------------|-----|-----|-----|
| SYSTEM DATA                  |      | MODEL NUMBER   |           |         | BRIDGE/RUNWAY DATA |       |    |     | FESTOON DATA |     |     |     |
| BL                           | RL   | CMT            | BL        | RL      | TS                 | BRH   | BH | C   | RH           | QTY | FTE | FCL |
| 8'                           | 34'  | CMT-8-34-730   | 2'-3 3/4" | 4 5/16" | 4 1/8"             | 1'-6" | 7  | 24" | 53'          |     |     |     |
|                              | 64'  | CMT-8-64-730   | 2'-3 3/4" | 4 5/16" | 4 1/8"             | 1'-6" | 12 | 36" | 86'          |     |     |     |
|                              | 94'  | CMT-8-94-730   | 2'-3 3/4" | 4 5/16" | 4 1/8"             | 1'-6" | 17 | 54" | 119'         |     |     |     |
|                              | 124' | CMT-8-124-730  | 2'-3 3/4" | 4 5/16" | 4 1/8"             | 1'-6" | 22 | 70" | 152'         |     |     |     |
| 10'                          | 34'  | CMT-10-34-730  | 2'-3 3/4" | 4 5/16" | 4 1/8"             | 1'-6" | 8  | 24" | 54'          |     |     |     |
|                              | 64'  | CMT-10-64-730  | 2'-3 3/4" | 4 5/16" | 4 1/8"             | 1'-6" | 13 | 36" | 88'          |     |     |     |
|                              | 94'  | CMT-10-94-730  | 2'-3 3/4" | 4 5/16" | 4 1/8"             | 1'-6" | 18 | 54" | 121'         |     |     |     |
|                              | 124' | CMT-10-124-730 | 2'-3 3/4" | 4 5/16" | 4 1/8"             | 1'-6" | 23 | 70" | 154'         |     |     |     |
| 15'                          | 34'  | CMT-15-34-730  | 2'-3 3/4" | 1'-0"   | 4 1/8"             | 1'-6" | 9  | 24" | 60'          |     |     |     |
|                              | 64'  | CMT-15-64-730  | 2'-3 3/4" | 1'-0"   | 4 1/8"             | 1'-6" | 14 | 36" | 93'          |     |     |     |
|                              | 94'  | CMT-15-94-730  | 2'-3 3/4" | 1'-0"   | 4 1/8"             | 1'-6" | 19 | 54" | 126'         |     |     |     |
|                              | 124' | CMT-15-124-730 | 2'-3 3/4" | 1'-0"   | 4 1/8"             | 1'-6" | 24 | 70" | 159'         |     |     |     |
| 20'                          | 34'  | CMT-20-34-730  | 2'-3 3/4" | 1'-0"   | 4 1/8"             | 1'-6" | 11 | 24" | 66'          |     |     |     |
|                              | 64'  | CMT-20-64-730  | 2'-3 3/4" | 1'-0"   | 4 1/8"             | 1'-6" | 16 | 36" | 99'          |     |     |     |
|                              | 94'  | CMT-20-94-730  | 2'-3 3/4" | 1'-0"   | 4 1/8"             | 1'-6" | 21 | 54" | 132'         |     |     |     |
|                              | 124' | CMT-20-124-730 | 2'-3 3/4" | 1'-0"   | 4 1/8"             | 1'-6" | 26 | 70" | 165'         |     |     |     |
| 23'                          | 34'  | CMT-23-34-730  | 2'-3 3/4" | 1'-0"   | 4 1/8"             | 1'-6" | 12 | 24" | 69'          |     |     |     |
|                              | 64'  | CMT-23-64-730  | 2'-3 3/4" | 1'-0"   | 4 1/8"             | 1'-6" | 17 | 36" | 102'         |     |     |     |
|                              | 94'  | CMT-23-94-730  | 2'-3 3/4" | 1'-0"   | 4 1/8"             | 1'-6" | 22 | 54" | 135'         |     |     |     |
|                              | 124' | CMT-23-124-730 | 2'-3 3/4" | 1'-0"   | 4 1/8"             | 1'-6" | 27 | 70" | 168'         |     |     |     |
| 28'                          | 34'  | CMT-28-34-730  | 2'-5 5/8" | 1'-4"   | 4 1/8"             | 1'-6" | 13 | 24" | 75'          |     |     |     |
|                              | 64'  | CMT-28-64-730  | 2'-5 5/8" | 1'-4"   | 4 1/8"             | 1'-6" | 18 | 36" | 108'         |     |     |     |
|                              | 94'  | CMT-28-94-730  | 2'-5 5/8" | 1'-4"   | 4 1/8"             | 1'-6" | 23 | 54" | 141'         |     |     |     |
|                              | 124' | CMT-28-124-730 | 2'-5 5/8" | 1'-4"   | 4 1/8"             | 1'-6" | 28 | 70" | 174'         |     |     |     |
| 34'                          | 34'  | CMT-34-34-730  | 2'-5 5/8" | 1'-6"   | 4 1/8"             | 1'-6" | 16 | 24" | 81'          |     |     |     |
|                              | 64'  | CMT-34-64-730  | 2'-5 5/8" | 1'-6"   | 4 1/8"             | 1'-6" | 21 | 36" | 114'         |     |     |     |
|                              | 94'  | CMT-34-94-730  | 2'-5 5/8" | 1'-6"   | 4 1/8"             | 1'-6" | 26 | 54" | 147'         |     |     |     |
|                              | 124' | CMT-34-124-730 | 2'-5 5/8" | 1'-6"   | 4 1/8"             | 1'-6" | 31 | 70" | 180'         |     |     |     |

**30'- 0" MAXIMUM SUPPORT CENTERS**  
**2,000 LB. CAPACITY**

**30' - 0" MAXIMUM SUPPORT CENTERS**

**8' - 10' - 15' - 20' - 23' - 28' - 34' BRIDGE LENGTH**

We have the solution for all your material handling needs.

SPANCO Lifting Solutions...

Ceiling mounted workstation  
bridge crane possibilities are  
infinite.

Call us for a local representative  
in your area. 800-869-2080

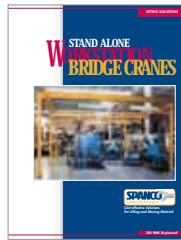

Stand Alone  
Workstation  
Bridge Cranes



Gantry Cranes



Workstation Jib  
Cranes



Jib Cranes



Aluminum  
Work Station  
Bridge Cranes



Fall Arrest Track



Retrofit Jib  
Drive



Beam Tractor  
Drive



604 Hemlock Road  
Morgantown, PA 19543 U.S.A.  
Tel: (610) 286-7200 Fax: (610) 286-0085  
1-800-869-2080 Canada & U.S.A.  
95-800-270-1080 Mexico

Visit SPANCO's Web site: [www.spanco.com](http://www.spanco.com)  
email: [sales@spanco.com](mailto:sales@spanco.com)

To request the featured literature,  
contact your authorized SPANCO  
distributor or call SPANCO at the  
numbers listed below.

Spanco Las Vegas Manufacturing Facility  
6835 Speedway Blvd. Suite L102  
Las Vegas, NV 89115 U.S.A.

